

3 COAT STUCCO

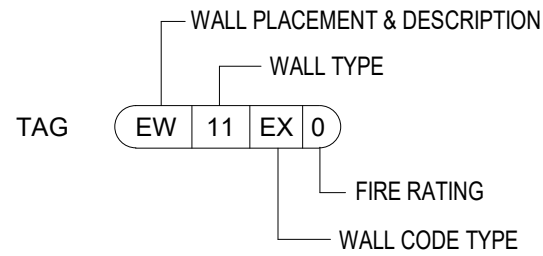

NAME: EW\_F\_11\_0 (3KS\_1GB)

COMMENT: EXT WD

ASSEMBLY: N/A

DESCRIPTION: TYPICAL EXTERIOR WALL  
NON-RATED

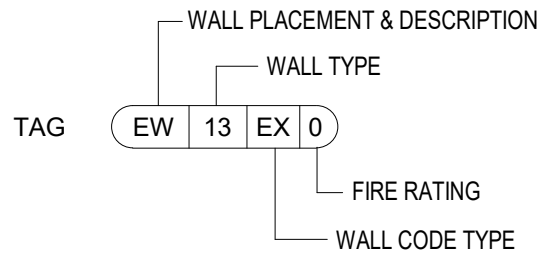

NAME: EW\_F\_13\_0 (3KS\_3KS)

COMMENT: EXT WD

ASSEMBLY: N/A

DESCRIPTION: EXTERIOR WALL WITH STUCCO  
ON BOTH SIDES NON-RATED

1 COAT STUCCO

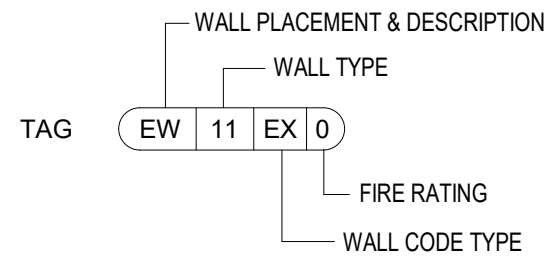

NAME: EW\_F\_11\_0 (1KS\_1GB)

COMMENT: EXT WD

ASSEMBLY: N/A

DESCRIPTION: TYPICAL EXTERIOR WALL  
NON-RATED

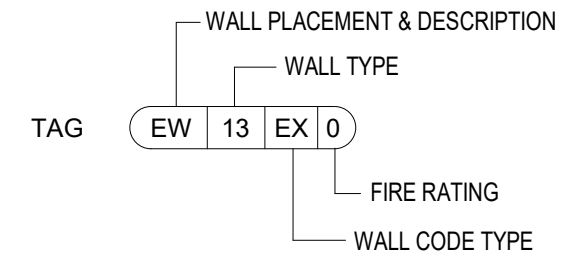

NAME: EW\_F\_13\_0 (1KS\_1KS)

COMMENT: EXT WD

ASSEMBLY: N/A

DESCRIPTION: EXTERIOR WALL WITH STUCCO  
ON BOTH SIDES NON-RATED

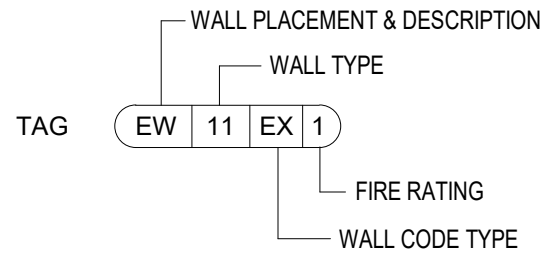

NAME: EW\_F\_11\_1 (3KS\_1GB)

COMMENT: EXT WD

ASSEMBLY: UL U356

DESCRIPTION: TYPICAL EXTERIOR WALL 1-HR  
RATED

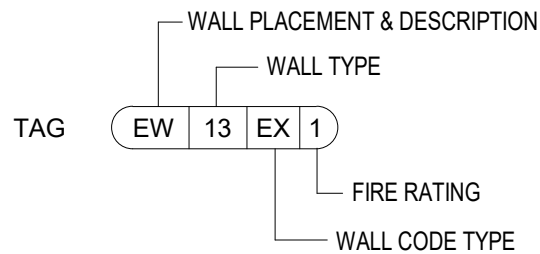

NAME: EW\_F\_13\_1 (3KS\_3KS)

COMMENT: EXT WD

ASSEMBLY: IBC 721.1 (2)\_ITEM 15-1.2

DESCRIPTION: EXTERIOR WALL WITH STUCCO  
ON BOTH SIDES 1-HR RATED

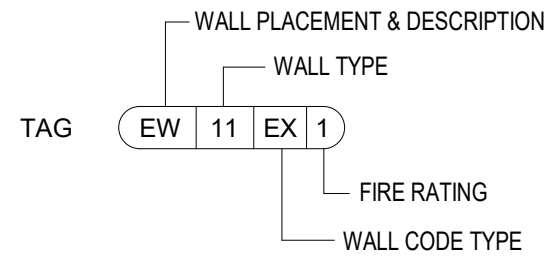

NAME: EW\_F\_11\_1 (1KS\_1GB)

COMMENT: EXT WD

ASSEMBLY: IBC 721.1(2) ITEM 15-1.3

DESCRIPTION: TYPICAL EXTERIOR WALL 1-HR  
RATED

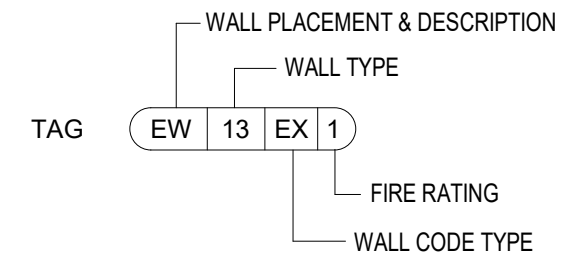

NAME: EW\_F\_13\_1 (1KS\_1KS)

COMMENT: EXT WD

ASSEMBLY: IBC 721.1 (2)\_ITEM 15-1.2

DESCRIPTION: EXTERIOR WALL WITH STUCCO  
ON BOTH SIDES 1-HR RATED

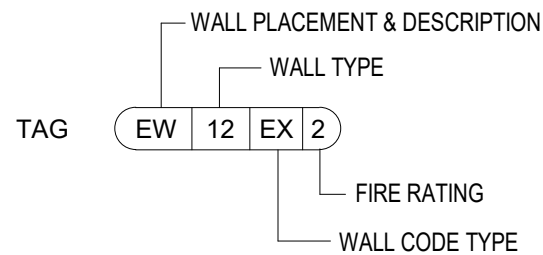

NAME: EW\_F\_12\_2 (3KS\_2GB)

COMMENT: EXT WD

ASSEMBLY: UL V314

DESCRIPTION: TYPICAL EXTERIOR WALL 2-HR  
RATED

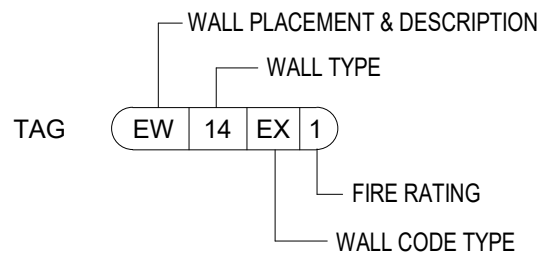

NAME: EW\_F\_14\_1 (3KS\_NA) Unit Separation

COMMENT: EXT WD

ASSEMBLY: GA WP 5512

DESCRIPTION: UNIT SEPARATION WALL WITH  
STUCCO

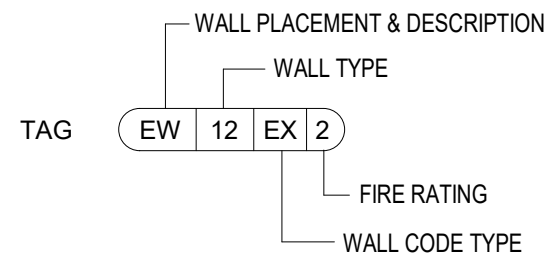

NAME: EW\_F\_12\_2 (1KS\_2GB)

COMMENT: EXT WD

ASSEMBLY: UL U371

DESCRIPTION: TYPICAL EXTERIOR WALL 2-HR  
RATED

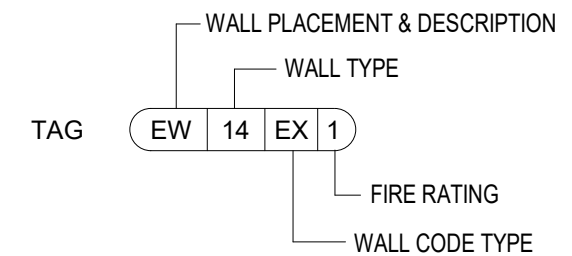

NAME: EW\_F\_14\_1 (1KS\_NA) Unit Separation

COMMENT: EXT WD

ASSEMBLY: GA WP 5512

DESCRIPTION: UNIT SEPARATION WALL WITH  
STUCCO



**ORB ASSEMBLIES**  
EXTERIOR WOOD STUD WALLS

**01-EW-F-01**

DATE:  
04/11/23

5/3/2023 3:05:19 PM

J:\Andres\_Fernandez\Revise to HIVE\Wall Assemblies\ORB Assemblies\Split\_Walls\_2023.rvt

### EIFS WOOD STUD

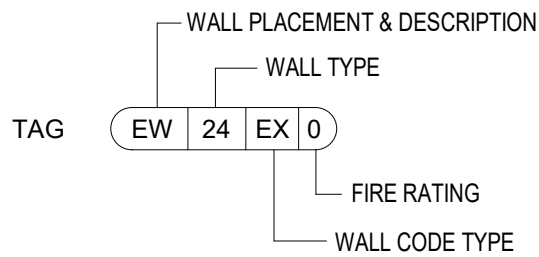

NAME: EW\_F\_24\_0 (EIFS\_2GB)

COMMENT: EXT WD

ASSEMBLY: N/A

DESCRIPTION: EXTERIOR WALL WITH EIFS ON BOTH SIDES NON-RATED

### EIFS WOOD STUD

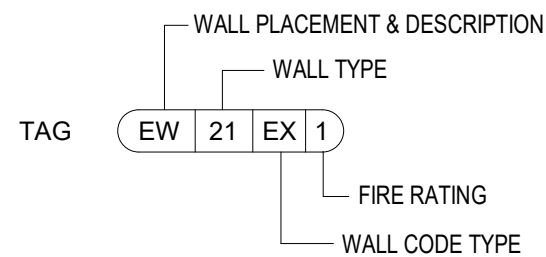

NAME: EW\_F\_21\_1 (EIFS\_1GB)

COMMENT: EXT WD

ASSEMBLY: UL U356

DESCRIPTION: TYPICAL EXTERIOR WALL 1-HR RATED

### GARAGE WRAP - WOOD STUD

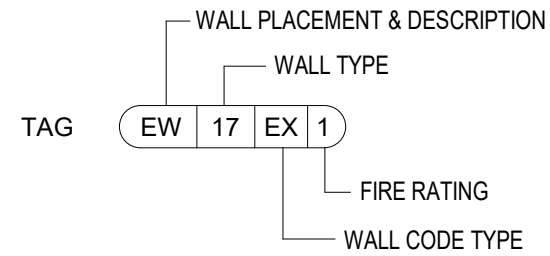

NAME: EW\_17\_1 (4\_1GB)

COMMENT: EXT WD

ASSEMBLY: IBC TABLE 721.1(2) ITEM 16-1.1

DESCRIPTION: GARAGE WRAP EXTERIOR WALL - 1-HR RATED

### 3-COAT STUCCO

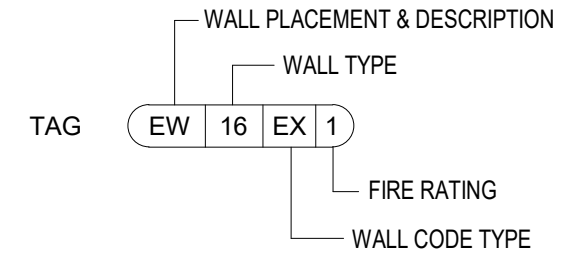

NAME: EW\_F\_16\_1 (3KS\_1GB)

COMMENT: EXT WD

ASSEMBLY: UL U346

DESCRIPTION: TYPICAL EXTERIOR WALL 1-HR RATED FROM BOTH SIDES

### 1-COAT STUCCO

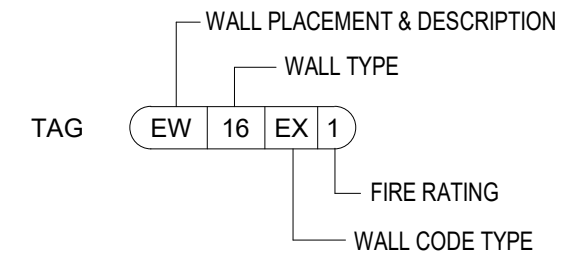

NAME: EW\_F\_16\_1 (1KS\_1GB)

COMMENT: EXT WD

ASSEMBLY: UL U346

DESCRIPTION: TYPICAL EXTERIOR WALL 1-HR RATED FROM BOTH SIDES

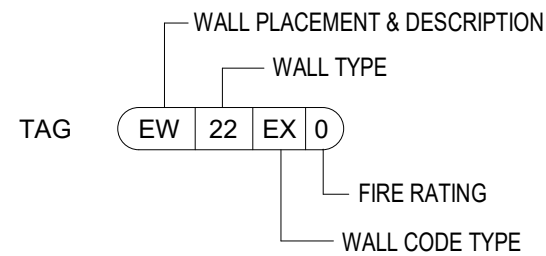

NAME: EW\_F\_22\_0 (EIFS\_1GB)

COMMENT: EXT WD

ASSEMBLY: N/A

DESCRIPTION: EXTERIOR WALL WITH EIFS ON BOTH SIDES NON-RATED

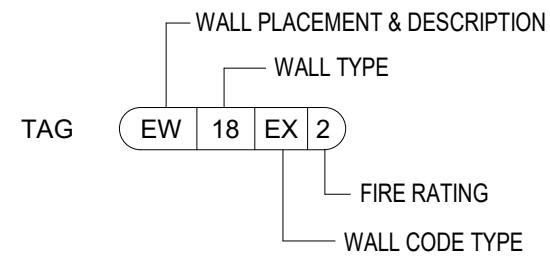

NAME: EW\_18\_2 (4\_2GB)

COMMENT: EXT WD

ASSEMBLY: UL DESIGN NO V314

DESCRIPTION: GARAGE WRAP EXTERIOR WALL - 2-HR RATED

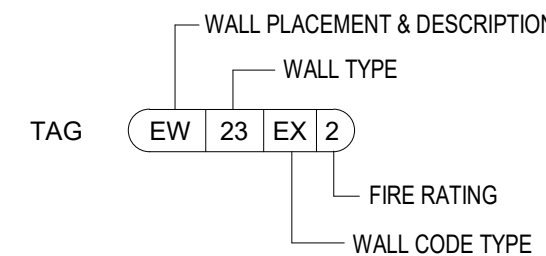

NAME: EW\_F\_23\_2 (EIFS\_2GB)

COMMENT: EXT WD

ASSEMBLY: UL V314

DESCRIPTION: TYPICAL EXTERIOR WALL 2 HOUR RATED



**ORB ASSEMBLIES**

**EXTERIOR WOOD STUD WALLS**

**01-EW-F-02**

DATE:  
04/11/23

U:\Andres\_Fernandez\Revise to\_HIVE\Wall\_Assemblies\ORB\_Assemblies\_Split\_Walls\_2023.rvt 5/3/2023 3:05:20 PM

**METAL SIDING**

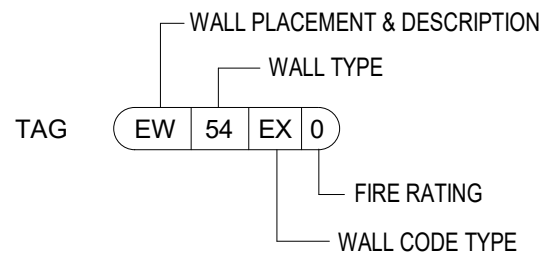

NAME: EWV\_F\_54\_0 (Mtl.S\_3KS)  
 COMMENT: VENEER ON EXT WD  
 ASSEMBLY: N/A  
 DESCRIPTION: WALL WITH METAL SIDING VENEER - STUCCO INSIDE

**METAL SIDING**

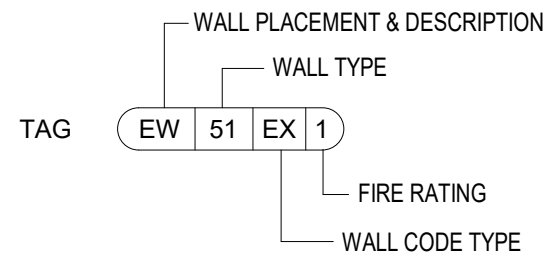

NAME: EWV\_F\_51\_1 (Mtl.S\_1GB)  
 COMMENT: VENEER ON EXT WD  
 ASSEMBLY: UL U356  
 DESCRIPTION: WALL WITH METAL SIDING VENEER - GYP INSIDE

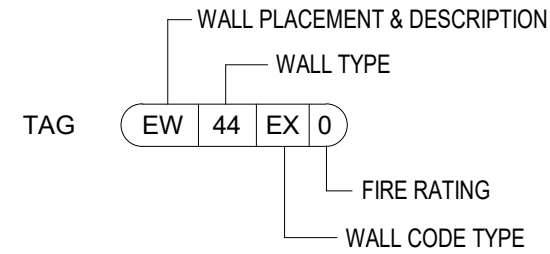

NAME: EWV\_F\_44\_0 (CB\_3KS)  
 COMMENT: VENEER ON EXT WD  
 ASSEMBLY: N/A  
 DESCRIPTION: WALL WITH CEMENT BOARD - STUCCO INSIDE

**CEMENT BOARD**

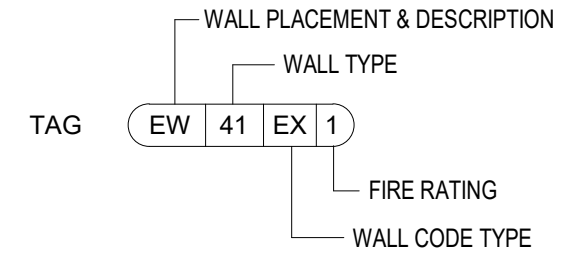

NAME: EWV\_F\_41\_1 (CB\_1GB)  
 COMMENT: VENEER ON EXT WD  
 ASSEMBLY: UL U356  
 DESCRIPTION: WALL WITH CEMENT BOARD - GYP INSIDE

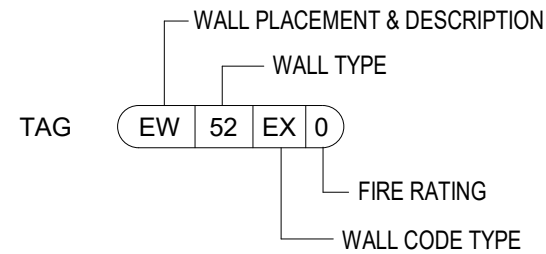

NAME: EWV\_F\_52\_0 (Mtl.S\_3KS)  
 COMMENT: VENEER ON EXT WD  
 ASSEMBLY: IBC TABLE 721.1(2) 15-1.3  
 DESCRIPTION: WALL WITH METAL SIDING VENEER - STUCCO INSIDE

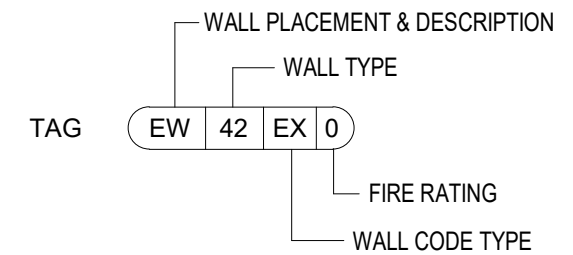

NAME: EWV\_F\_42\_0 (CB\_3KS)  
 COMMENT: VENEER ON EXT WD  
 ASSEMBLY: IBC TABLE 721.1(2) 15-1.3  
 DESCRIPTION: WALL WITH CEMENT BOARD - STUCCO INSIDE

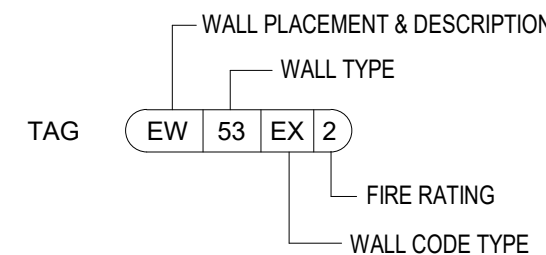

NAME: EWV\_F\_53\_2 (Mtl.S\_2GB)  
 COMMENT: VENEER ON EXT WD  
 ASSEMBLY: UL V314  
 DESCRIPTION: WALL WITH METAL SIDING VENEER - (2) GYP INSIDE

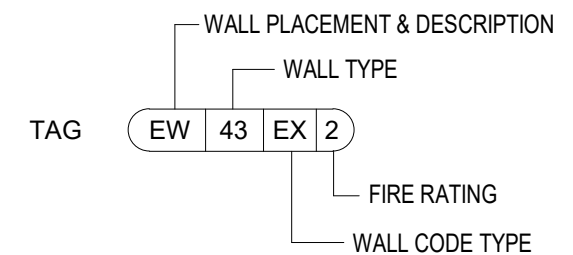

NAME: EWV\_F\_43\_2 (CB\_2GB)  
 COMMENT: VENEER ON EXT WD  
 ASSEMBLY: UL V314  
 DESCRIPTION: WALL WITH CEMENT BOARD - (2) GYP INSIDE



**ORB ASSEMBLIES**  
 EXTERIOR WOOD STUD WALLS

**01-EW-F-03**

DATE:  
04/11/23

U:\Andres\_Fernandez\Revise to\_HIVE\Wall\_Assemblies\ORB\_Assemblies\_Split\_Walls\_2023.rvt 5/3/2023 3:05:20 PM

**CMU VENEER**

WALL PLACEMENT & DESCRIPTION

WALL TYPE

TAG EW 64 EX 0

FIRE RATING

WALL CODE TYPE

NAME: EWV\_F\_64\_0 (UV\_3KS)  
 COMMENT: VENEER ON EXT WD  
 ASSEMBLY: N/A  
 DESCRIPTION: WALL WITH CMU VENEER - STUCCO INSIDE

**CMU VENEER**

WALL PLACEMENT & DESCRIPTION

WALL TYPE

TAG EW 61 EX 1

FIRE RATING

WALL CODE TYPE

NAME: EWV\_F\_61\_1 (UV\_1GB)  
 COMMENT: VENEER ON EXT WD  
 ASSEMBLY: UL U356  
 DESCRIPTION: WALL WITH CMU VENEER - GYP INSIDE

**BRICK VENEER**

WALL PLACEMENT & DESCRIPTION

WALL TYPE

TAG EW 59 EX 0

FIRE RATING

WALL CODE TYPE

NAME: EWV\_F\_59\_0 (BV\_3KS)  
 COMMENT: VENEER ON EXT WD  
 ASSEMBLY: N/A  
 DESCRIPTION: WALL WITH BRICK VENEER - STUCCO INSIDE

**BRICK VENEER**

WALL PLACEMENT & DESCRIPTION

WALL TYPE

TAG EW 56 EX 1

FIRE RATING

WALL CODE TYPE

NAME: EWV\_F\_56\_1 (BV\_1GB)  
 COMMENT: VENEER ON EXT WD  
 ASSEMBLY: UL U356  
 DESCRIPTION: WALL WITH BRICK VENEER - GYP INSIDE

WALL PLACEMENT & DESCRIPTION

WALL TYPE

TAG EW 63 EX 0

FIRE RATING

WALL CODE TYPE

NAME: EWV\_F\_62\_0 (UV\_3KS)  
 COMMENT: VENEER ON EXT WD  
 ASSEMBLY: IBC 721.1(2) ITEM 15-1.3  
 DESCRIPTION: WALL WITH CMU VENEER - STUCCO INSIDE

WALL PLACEMENT & DESCRIPTION

WALL TYPE

TAG EW 57 EX 0

FIRE RATING

WALL CODE TYPE

NAME: EWV\_F\_57\_0 (BV\_3KS)  
 COMMENT: VENEER ON EXT WD  
 ASSEMBLY: IBC TABLE 721.1(2) 15-1.3  
 DESCRIPTION: WALL WITH BRICK VENEER - STUCCO INSIDE

WALL PLACEMENT & DESCRIPTION

WALL TYPE

TAG EW 63 EX 2

FIRE RATING

WALL CODE TYPE

NAME: EWV\_F\_63\_2 (UV\_2GB)  
 COMMENT: VENEER ON EXT WD  
 ASSEMBLY: UL V314  
 DESCRIPTION: WALL WITH CMU VENEER - (2) GYP INSIDE

WALL PLACEMENT & DESCRIPTION

WALL TYPE

TAG EW 58 EX 2

FIRE RATING

WALL CODE TYPE

NAME: EWV\_F\_58\_2 (BV\_2GB)  
 COMMENT: VENEER ON EXT WD  
 ASSEMBLY: UL V314  
 DESCRIPTION: WALL WITH BRICK VENEER - (2) GYP INSIDE



**ORB ASSEMBLIES**  
EXTERIOR WOOD STUD WALLS

**01-EW-F-04**

DATE:  
04/11/23

3 COAT STUCCO

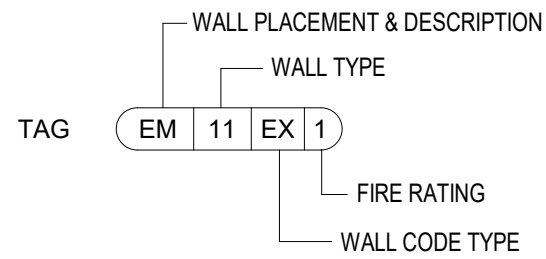

NAME: EM\_F\_11\_1 (3KS\_1GB)

COMMENT: EXT MTL

ASSEMBLY: IBC 721.1(2) ITEM 15-1.4

DESCRIPTION: TYPICAL EXTERIOR WALL 1-HR RATED

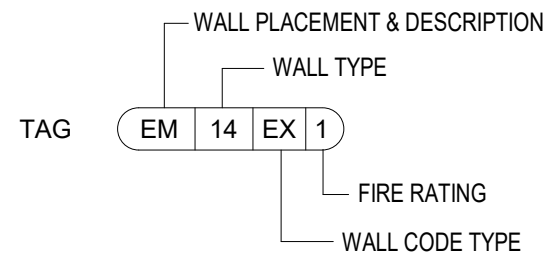

NAME: EM\_F\_14\_1 (3KS\_NA) Unit Separation

COMMENT: EXT MTL

ASSEMBLY: UL V469

DESCRIPTION: UNIT SEPARATION WALL WITH STUCCO

1 COAT STUCCO

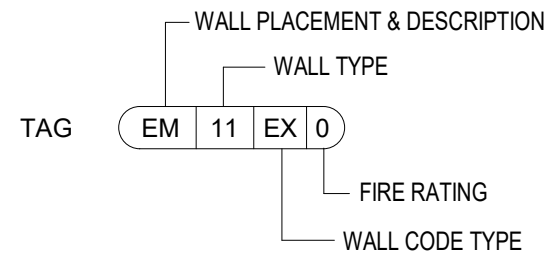

NAME: EM\_F\_11\_0 (1KS\_1GB)

COMMENT: EXT MTL

ASSEMBLY: N/A

DESCRIPTION: TYPICAL EXTERIOR WALL NON-RATED

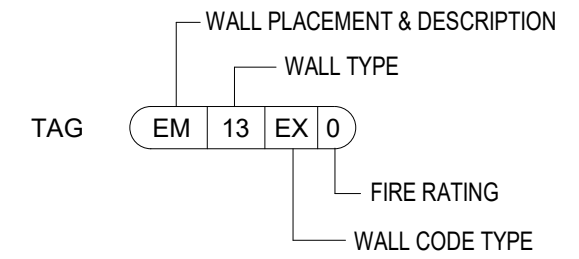

NAME: EM\_F\_13\_0 (1KS\_1KS)

COMMENT: EXT MTL

ASSEMBLY: N/A

DESCRIPTION: EXTERIOR WALL WITH STUCCO ON BOTH SIDES NON-RATED

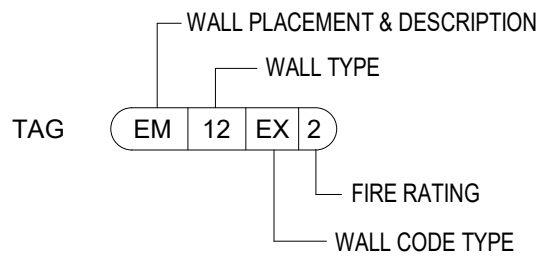

NAME: EM\_F\_12\_2 (3KS\_2GB)

COMMENT: EXT MTL

ASSEMBLY: UL U423

DESCRIPTION: TYPICAL EXTERIOR WALL 2-HR RATED

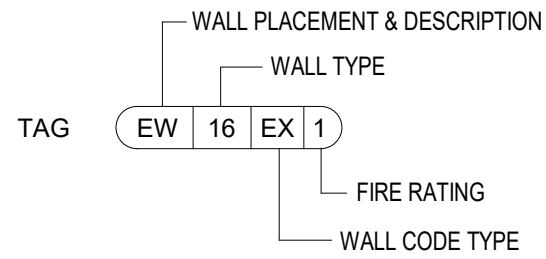

NAME: EM\_F\_16\_1 (3KS\_1GB)

COMMENT: EXT WD

ASSEMBLY: UL U423

DESCRIPTION: TYPICAL EXTERIOR WALL 1-HR RATED FROM BOTH SIDES

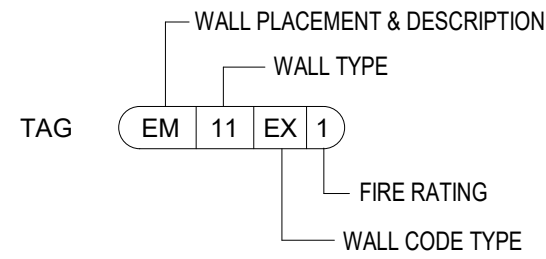

NAME: EM\_F\_11\_1 (1KS\_1GB)

COMMENT: EXT MTL

ASSEMBLY: IBC 721.1 (2)\_ITEM 15-1.11

DESCRIPTION: TYPICAL EXTERIOR WALL 1-HR RATED

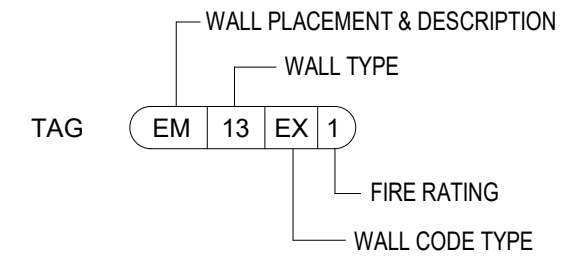

NAME: EM\_F\_13\_1 (1KS\_1KS)

COMMENT: EXT MTL

ASSEMBLY: IBC 721.1 (2)\_ITEM 15-1.11

DESCRIPTION: EXTERIOR WALL WITH STUCCO ON BOTH SIDES 1-HR RATED

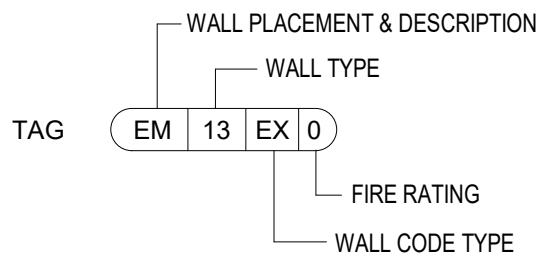

NAME: EM\_F\_13\_0 (3KS\_3KS)

COMMENT: EXT MTL

ASSEMBLY: N/A

DESCRIPTION: EXTERIOR WALL WITH STUCCO ON BOTH SIDES NON-RATED

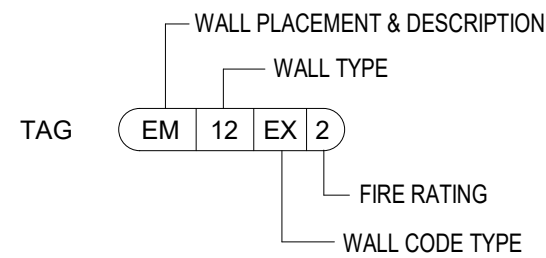

NAME: EM\_F\_12\_2 (1KS\_2GB)

COMMENT: EXT MTL

ASSEMBLY: IBC 721.1 (2)\_ITEM 15-1.10

DESCRIPTION: TYPICAL EXTERIOR WALL 2-HR RATED

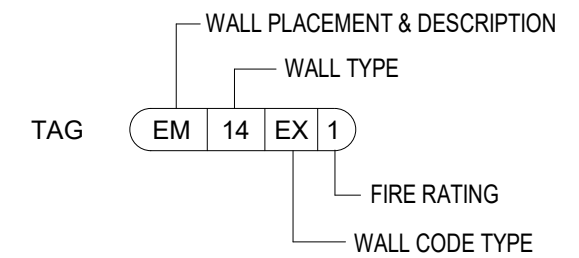

NAME: EM\_F\_14\_1 (1KS\_NA) Unit Separation

COMMENT: EXT MTL

ASSEMBLY: IBC 721.1 (2)\_ITEM 15-1.11

DESCRIPTION: UNIT SEPARATION WALL WITH STUCCO



ORB ASSEMBLIES  
EXTERIOR METAL STUD ASSEMBLIES

02-EM-F-01

DATE:  
04/11/23

U:\Andres\_Fernandez\Revise to HIVE\Wall Assemblies\ORB Assemblies\Split\_Walls\_2023.rvt 5/3/2023 3:05:21 PM

**BRICK VENEER**

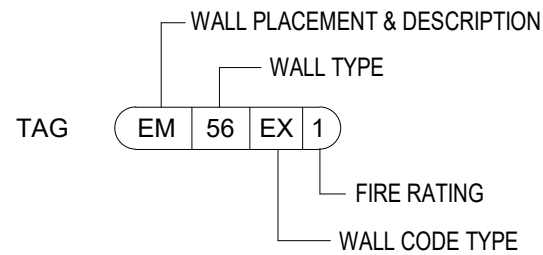

NAME: EMV\_F\_56\_1 (BV\_1GB)  
 COMMENT: VENEER ON EXT MTL  
 ASSEMBLY: UL U423  
 DESCRIPTION: WALL WITH BRICK VENEER - GYP INSIDE

**METAL SIDING**

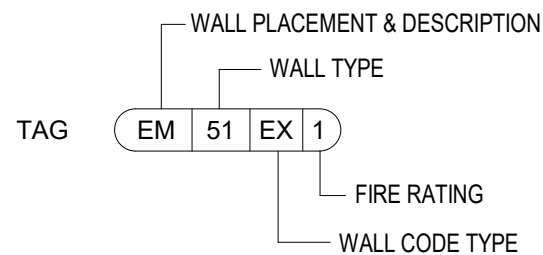

NAME: EMV\_F\_51\_1 (Mtl.S\_1GB)  
 COMMENT: VENEER ON EXT MTL  
 ASSEMBLY: UL U423  
 DESCRIPTION: WALL WITH METAL SIDING VENEER - GYP INSIDE

**CEMENT BOARD**

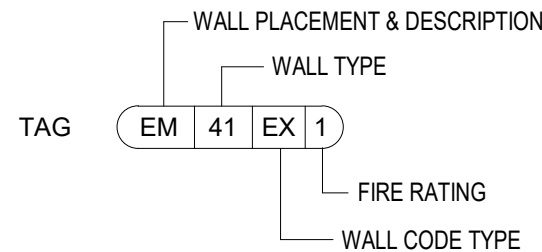

NAME: EMV\_F\_41\_1 (CB\_1GB)  
 COMMENT: VENEER ON EXT MTL  
 ASSEMBLY: GA WP 8006  
 DESCRIPTION: WALL WITH CEMENT BOARD - GYP INSIDE

**EIFS METAL STUD**

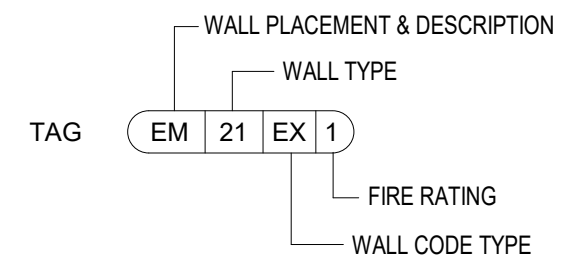

NAME: EM\_F\_21\_1 (EIFS\_1GB)  
 COMMENT: EXT MTL  
 ASSEMBLY: GA WP 8006  
 DESCRIPTION: TYPICAL EXTERIOR WALL 1-HR RATED

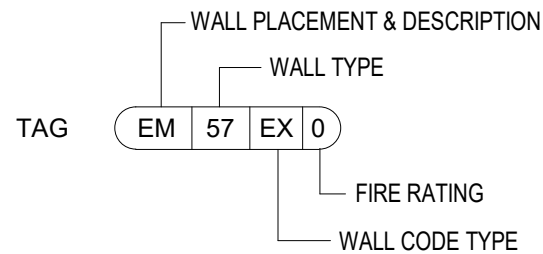

NAME: EMV\_F\_57\_0 (BV\_3KS)  
 COMMENT: VENEER ON EXT MTL  
 ASSEMBLY: N/A  
 DESCRIPTION: WALL WITH BRICK VENEER - STUCCO INSIDE

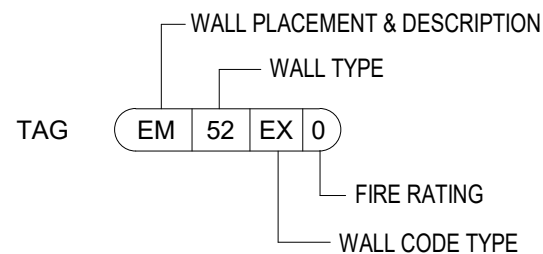

NAME: EMV\_F\_52\_0 (Mtl.S\_3KS)  
 COMMENT: VENEER ON EXT MTL  
 ASSEMBLY: N/A  
 DESCRIPTION: WALL WITH METAL SIDING VENEER - STUCCO INSIDE

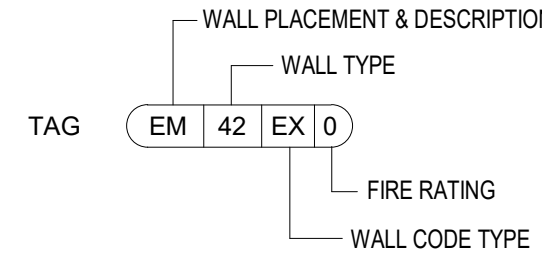

NAME: EMV\_F\_42\_0 (CB\_3KS)  
 COMMENT: VENEER ON EXT WD  
 ASSEMBLY: N/A  
 DESCRIPTION: WALL WITH CEMENT BOARD - STUCCO INSIDE

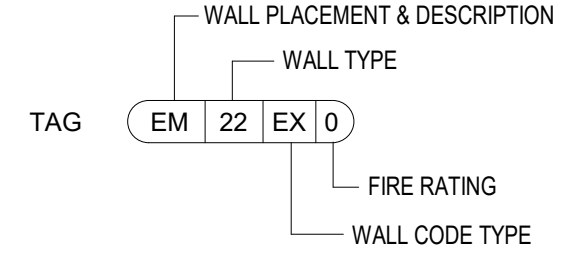

NAME: EM\_F\_22\_0 (EIFS\_1GB)  
 COMMENT: EXT MTL  
 ASSEMBLY: N/A  
 DESCRIPTION: EXTERIOR WALL WITH EIFS ON BOTH SIDES NON-RATED

**ORB ASSEMBLIES**  
 EXTERIOR METAL STUD WALLS

**02-EM-F-02**

DATE:  
04/11/23

**HARDIE PLANK**

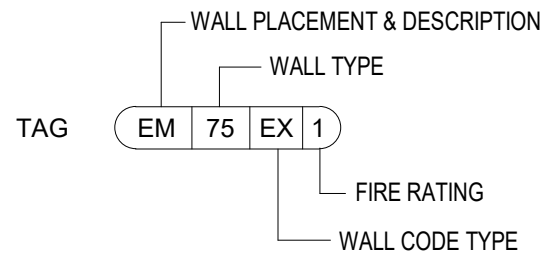

NAME: EMH\_F\_75\_1 (HP\_1GB)  
 COMMENT: HARDIE PLANK ON EXT WD  
 ASSEMBLY: GA WP 8006  
 DESCRIPTION: WALL WITH METAL SIDING VENEER - GYP INSIDE

**STONE VENEER**

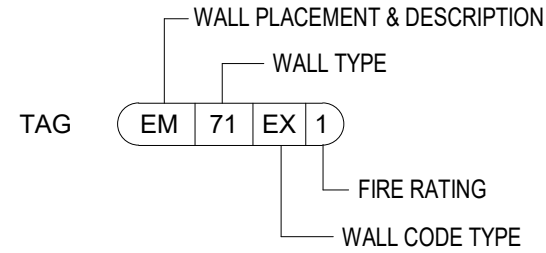

NAME: EMV\_F\_71\_1 (SV\_1GB)  
 COMMENT: VENEER ON EXT MTL  
 ASSEMBLY: GA WP 8006  
 DESCRIPTION: WALL WITH STONE VENEER - GYP INSIDE

**PRECAST VENEER**

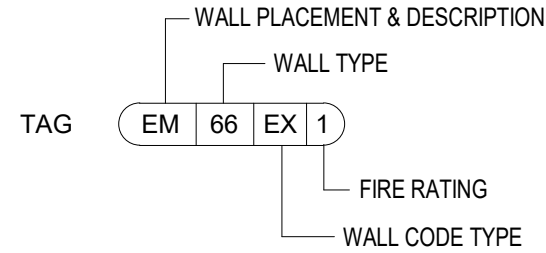

NAME: EMV\_F\_66\_1 (CV\_1GB)  
 COMMENT: VENEER ON EXT MTL  
 ASSEMBLY: GA WP 8006  
 DESCRIPTION: WALL WITH PRECAST VENEER - GYP INSIDE

**CMU VENEER**

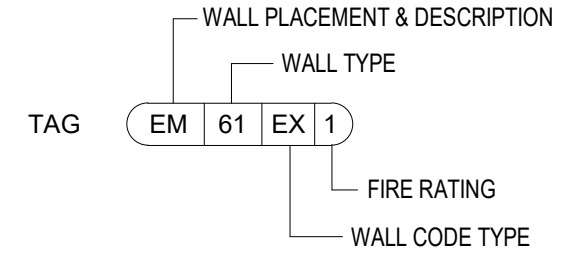

NAME: EMV\_F\_61\_1 (UV\_1GB)  
 COMMENT: VENEER ON EXT MTL  
 ASSEMBLY: GA WP 8006  
 DESCRIPTION: WALL WITH CMU VENEER - GYP INSIDE

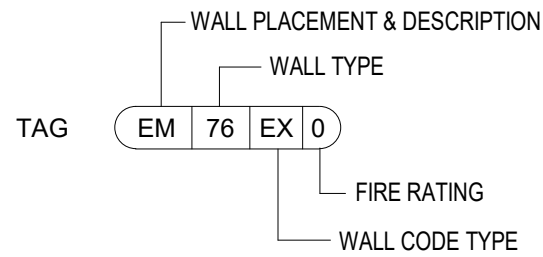

NAME: EMH\_F\_76\_0 (HP\_N/A)  
 COMMENT: HARDIE PLANK ON EXT WD  
 ASSEMBLY: N/A  
 DESCRIPTION: WALL WITH HARDIE PLANK - STUCCO INSIDE

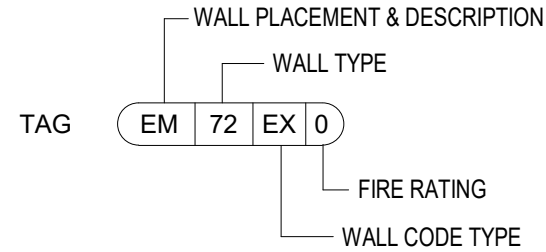

NAME: EMV\_F\_72\_0 (SV\_3KS)  
 COMMENT: VENEER ON EXT MTL  
 ASSEMBLY: N/A  
 DESCRIPTION: WALL WITH STONE VENEER - STUCCO INSIDE

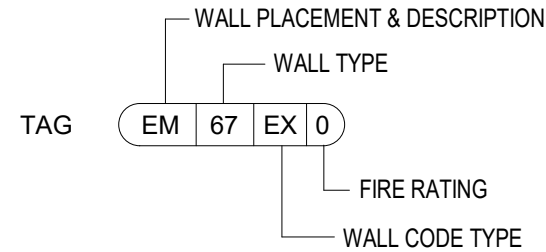

NAME: EMV\_F\_67\_0 (CV\_3KS)  
 COMMENT: VENEER ON EXT MTL  
 ASSEMBLY: N/A  
 DESCRIPTION: WALL WITH PRECAST VENEER - STUCCO INSIDE

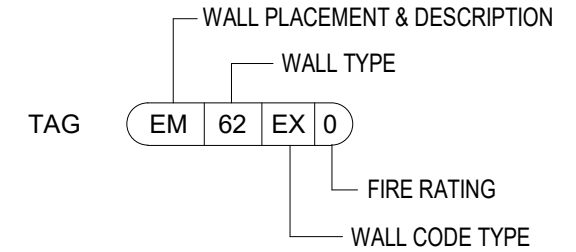

NAME: EMV\_F\_62\_0 (UV\_3KS)  
 COMMENT: VENEER ON EXT MTL  
 ASSEMBLY: N/A  
 DESCRIPTION: WALL WITH CMU VENEER - STUCCO INSIDE



**ORB ASSEMBLIES**  
 EXTERIOR METAL STUD WALLS

**02-EM-F-03**

DATE:  
 04/11/23

U:\Andres\_Fernandez\Revise to\_HIVE\Wall\_Assemblies\ORB\_Assemblies\_Split\_Walls\_2023.rvt 5/3/2023 3:05:22 PM

U:\Andres\_Fernandez\Revise to\_HIVE\Wall\_Assemblies\ORB\_Assemblies\_Split\_Walls\_2023.rvt 5/3/2023 3:05:23 PM



WALL PLACEMENT & DESCRIPTION

WALL TYPE

TAG EW S EX 0

FIRE RATING

WALL CODE TYPE

NAME: EW\_S\_0 (4\_1GB)

COMMENT: EXT WD

ASSEMBLY:

DESCRIPTION: TYPICAL EXTERIOR WALL NON-RATED



WALL PLACEMENT & DESCRIPTION

WALL TYPE

TAG EW S EX 0

FIRE RATING

WALL CODE TYPE

NAME: EW\_S\_0 (4\_NA)

COMMENT: EXT WD

ASSEMBLY:

DESCRIPTION: NON-RATED EXTERIOR WALL AT POP-OUTS (NO GYP INSIDE)



WALL PLACEMENT & DESCRIPTION

WALL TYPE

TAG EW S EX 0

FIRE RATING

WALL CODE TYPE

NAME: EW\_S\_0 (6\_3KS)

COMMENT: EXT WD

ASSEMBLY:

DESCRIPTION: EXTERIOR WALL WITH STUCCO ON BOTH SIDES NON-RATED



WALL PLACEMENT & DESCRIPTION

WALL TYPE

TAG EW S EX 0

FIRE RATING

WALL CODE TYPE

NAME: EW\_S\_0 (8\_1KS)

COMMENT: EXT WD

ASSEMBLY:

DESCRIPTION: EXTERIOR WALL WITH STUCCO ON BOTH SIDES NON-RATED



WALL PLACEMENT & DESCRIPTION

WALL TYPE

TAG EW S EX 0

FIRE RATING

WALL CODE TYPE

NAME: EW\_S\_0 (4\_1KS)

COMMENT: EXT WD

ASSEMBLY:

DESCRIPTION: EXTERIOR WALL WITH STUCCO ON BOTH SIDES NON-RATED



WALL PLACEMENT & DESCRIPTION

WALL TYPE

TAG EW S EX 0

FIRE RATING

WALL CODE TYPE

NAME: EW\_S\_0 (6\_1GB)

COMMENT: EXT WD

ASSEMBLY:

DESCRIPTION: TYPICAL EXTERIOR WALL NON-RATED



WALL PLACEMENT & DESCRIPTION

WALL TYPE

TAG EW S EX 0

FIRE RATING

WALL CODE TYPE

NAME: EW\_S\_0 (6\_NA)

COMMENT: EXT WD

ASSEMBLY:

DESCRIPTION: NON-RATED EXTERIOR WALL AT POP-OUTS (NO GYP INSIDE)



WALL PLACEMENT & DESCRIPTION

WALL TYPE

TAG EW S EX 0

FIRE RATING

WALL CODE TYPE

NAME: EW\_S\_0 (8\_3KS)

COMMENT: EXT WD

ASSEMBLY:

DESCRIPTION: EXTERIOR WALL WITH STUCCO ON BOTH SIDES NON-RATED



WALL PLACEMENT & DESCRIPTION

WALL TYPE

TAG EW S EX 0

FIRE RATING

WALL CODE TYPE

NAME: EW\_S\_0 (4\_3KS)

COMMENT: EXT WD

ASSEMBLY:

DESCRIPTION: EXTERIOR WALL WITH STUCCO ON BOTH SIDES NON-RATED



WALL PLACEMENT & DESCRIPTION

WALL TYPE

TAG EW S EX 0

FIRE RATING

WALL CODE TYPE

NAME: EW\_S\_0 (6\_1KS)

COMMENT: EXT WD

ASSEMBLY:

DESCRIPTION: EXTERIOR WALL WITH STUCCO ON BOTH SIDES NON-RATED



WALL PLACEMENT & DESCRIPTION

WALL TYPE

TAG EW S EX 0

FIRE RATING

WALL CODE TYPE

NAME: EW\_S\_0 (8\_1GB)

COMMENT: EXT WD

ASSEMBLY:

DESCRIPTION: TYPICAL EXTERIOR WALL NON-RATED



WALL PLACEMENT & DESCRIPTION

WALL TYPE

TAG EW S EX 0

FIRE RATING

WALL CODE TYPE

NAME: EW\_S\_0 (8\_NA)

COMMENT: EXT WD

ASSEMBLY:

DESCRIPTION: NON-RATED EXTERIOR WALL AT POP-OUTS (NO GYP INSIDE)



**ORB ASSEMBLIES**

EXTERIOR WOOD STRUCTURE WALLS

**03-EW-S-00**

DATE:  
FEBRUARY 24, 2020



U:\Andres\_Fernandez\Revise to HIVE\Wall Assemblies\ORB Assemblies\_Split\_Walls\_2023.rvt 5/3/2023 3:05:23 PM



WALL PLACEMENT & DESCRIPTION

WALL TYPE

TAG EW S EX 1

FIRE RATING

WALL CODE TYPE

NAME: EW\_S\_1 (4\_1GB)

COMMENT: EXT WD

ASSEMBLY:

DESCRIPTION: TYPICAL EXTERIOR WALL 1-HR RATED



WALL PLACEMENT & DESCRIPTION

WALL TYPE

TAG EW S EX 1

FIRE RATING

WALL CODE TYPE

NAME: EW\_S\_1 (4\_NA)

COMMENT: EXT WD

ASSEMBLY:

DESCRIPTION: TYPICAL EXTERIOR WALL AT POP-OUTS (NO GYP INSIDE)



WALL PLACEMENT & DESCRIPTION

WALL TYPE

TAG EW S EX 1

FIRE RATING

WALL CODE TYPE

NAME: EW\_S\_1 (6\_1KS)

COMMENT: EXT WD

ASSEMBLY:

DESCRIPTION: EXTERIOR WALL WITH STUCCO ON BOTH SIDES 1-HR RATED



WALL PLACEMENT & DESCRIPTION

WALL TYPE

TAG EW S EX 1

FIRE RATING

WALL CODE TYPE

NAME: EW\_S\_1 (6\_NA) Unit Separation

COMMENT: EXT WD

ASSEMBLY:

DESCRIPTION: UNIT SEPARATION WALL WITH STUCCO



WALL PLACEMENT & DESCRIPTION

WALL TYPE

TAG EW S EX 1

FIRE RATING

WALL CODE TYPE

NAME: EW\_S\_1 (6\_1GB)

COMMENT: EXT WD

ASSEMBLY:

DESCRIPTION: TYPICAL EXTERIOR WALL 1-HR RATED



WALL PLACEMENT & DESCRIPTION

WALL TYPE

TAG EW S EX 1

FIRE RATING

WALL CODE TYPE

NAME: EW\_S\_1 (4\_NA) Unit Separation

COMMENT: EXT WD

ASSEMBLY:

DESCRIPTION: UNIT SEPARATION WALL WITH STUCCO



WALL PLACEMENT & DESCRIPTION

WALL TYPE

TAG EW S EX 1

FIRE RATING

WALL CODE TYPE

NAME: EW\_S\_1 (6\_3KS)

COMMENT: EXT WD

ASSEMBLY:

DESCRIPTION: EXTERIOR WALL WITH STUCCO ON BOTH SIDES 1-HR RATED



WALL PLACEMENT & DESCRIPTION

WALL TYPE

TAG EW S EX 1

FIRE RATING

WALL CODE TYPE

NAME: EW\_S\_1 (8\_1GB)

COMMENT: EXT WD

ASSEMBLY:

DESCRIPTION: TYPICAL EXTERIOR WALL 1-HR RATED



WALL PLACEMENT & DESCRIPTION

WALL TYPE

TAG EW S EX 1

FIRE RATING

WALL CODE TYPE

NAME: EW\_S\_1 (4\_3KS)

COMMENT: EXT WD

ASSEMBLY:

DESCRIPTION: EXTERIOR WALL WITH STUCCO ON BOTH SIDES 1-HR RATED



WALL PLACEMENT & DESCRIPTION

WALL TYPE

TAG EW S EX 1

FIRE RATING

WALL CODE TYPE

NAME: EW\_S\_1 (6\_1GB)

COMMENT: EXT WD

ASSEMBLY:

DESCRIPTION: TYPICAL EXTERIOR WALL 1-HR RATED



WALL PLACEMENT & DESCRIPTION

WALL TYPE

TAG EW S EX 1

FIRE RATING

WALL CODE TYPE

NAME: EW\_S\_1 (6\_NA)

COMMENT: EXT WD

ASSEMBLY:

DESCRIPTION: TYPICAL EXTERIOR WALL AT POP-OUTS (NO GYP INSIDE)



WALL PLACEMENT & DESCRIPTION

WALL TYPE

TAG EW S EX 1

FIRE RATING

WALL CODE TYPE

NAME: EW\_S\_1 (8\_1KS)

COMMENT: EXT WD

ASSEMBLY:

DESCRIPTION: EXTERIOR WALL WITH STUCCO ON BOTH SIDES 1-HR RATED



**ORB ASSEMBLIES**

EXTERIOR WOOD STRUCTURE WALLS

**03-EW-S-01**

DATE:  
04/04/20

U:\Andres\_Fernandez\Revise to\_HIVE\Wall\_Assemblies\ORB\_Assemblies\_Split\_Walls\_2023.rvt 5/3/2023 3:05:24 PM

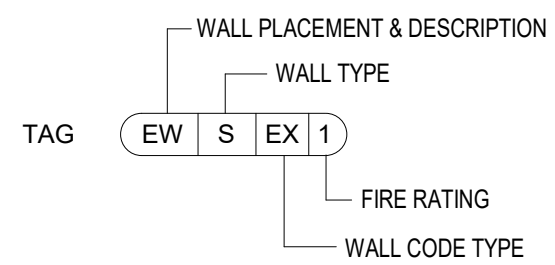

NAME: EW\_S\_1 (8\_3KS)

COMMENT: EXT WD

ASSEMBLY:

DESCRIPTION: EXTERIOR WALL WITH STUCCO ON BOTH SIDES 1-HR RATED

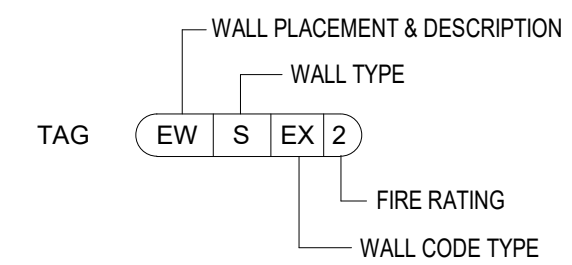

NAME: EW\_S\_2 (4\_2GB)

COMMENT: EXT WD

ASSEMBLY:

DESCRIPTION: TYPICAL EXTERIOR WALL 2-HR RATED

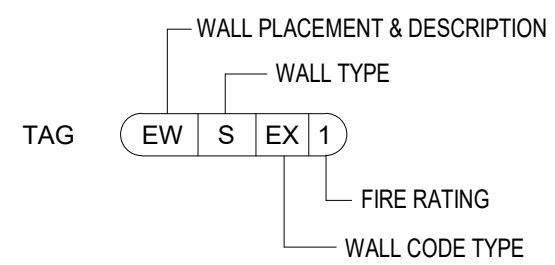

NAME: EW\_S\_1 (8\_NA)

COMMENT: EXT WD

ASSEMBLY:

DESCRIPTION: TYPICAL EXTERIOR WALL AT POP-OUTS (NO GYP INSIDE)

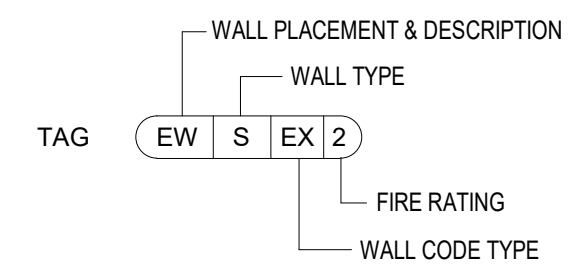

NAME: EW\_S\_2 (6\_2GB)

COMMENT: EXT WD

ASSEMBLY:

DESCRIPTION: TYPICAL EXTERIOR WALL 2-HR RATED

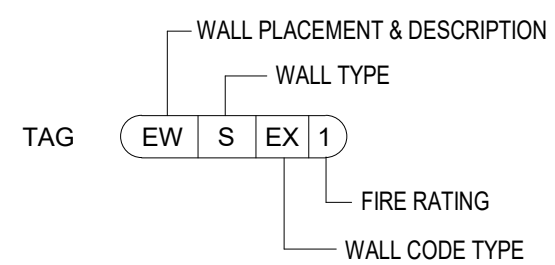

NAME: EW\_S\_1 (8\_NA) Unit Separation

COMMENT: EXT WD

ASSEMBLY:

DESCRIPTION: UNIT SEPARATION WALL WITH STUCCO

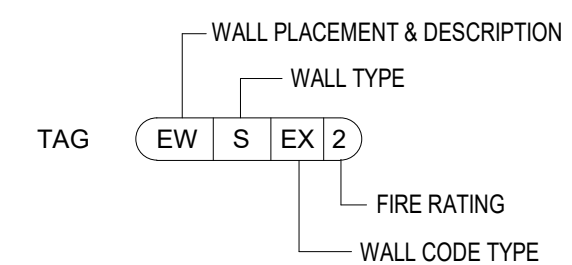

NAME: EW\_S\_2 (8\_2GB)

COMMENT: EXT WD

ASSEMBLY:

DESCRIPTION: TYPICAL EXTERIOR WALL 2-HR RATED



**ORB ASSEMBLIES**

EXTERIOR WOOD STRUCTURE WALLS

**03-EW-S-02**

DATE:  
04/04/20

U:\Andres\_Fernandez\Revise to\_HIVE\Wall\_Assemblies\ORB\_Assemblies\_Split\_Walls\_2023.rvt 5/3/2023 3:05:25 PM



WALL PLACEMENT & DESCRIPTION

WALL TYPE

TAG EM S EX 0

FIRE RATING

WALL CODE TYPE

NAME: EM\_S\_0 (4\_1GB)

COMMENT: EXT MTL

ASSEMBLY:

DESCRIPTION: TYPICAL EXTERIOR WALL NON-RATED



WALL PLACEMENT & DESCRIPTION

WALL TYPE

TAG EM S EX 0

FIRE RATING

WALL CODE TYPE

NAME: EM\_S\_0 (4\_NA)

COMMENT: EXT MTL

ASSEMBLY:

DESCRIPTION: NON-RATED EXTERIOR WALL AT POP-OUTS (NO GYP INSIDE)



WALL PLACEMENT & DESCRIPTION

WALL TYPE

TAG EM S EX 0

FIRE RATING

WALL CODE TYPE

NAME: EM\_S\_0 (6\_3KS)

COMMENT: EXT MTL

ASSEMBLY:

DESCRIPTION: EXTERIOR WALL WITH STUCCO ON BOTH SIDES NON-RATED



WALL PLACEMENT & DESCRIPTION

WALL TYPE

TAG EM S EX 0

FIRE RATING

WALL CODE TYPE

NAME: EM\_S\_0 (8\_1KS)

COMMENT: EXT MTL

ASSEMBLY:

DESCRIPTION: EXTERIOR WALL WITH STUCCO ON BOTH SIDES NON-RATED



WALL PLACEMENT & DESCRIPTION

WALL TYPE

TAG EM S EX 0

FIRE RATING

WALL CODE TYPE

NAME: EM\_S\_0 (4\_1KS)

COMMENT: EXT MTL

ASSEMBLY:

DESCRIPTION: EXTERIOR WALL WITH STUCCO ON BOTH SIDES NON-RATED



WALL PLACEMENT & DESCRIPTION

WALL TYPE

TAG EM S EX 0

FIRE RATING

WALL CODE TYPE

NAME: EM\_S\_0 (6\_1GB)

COMMENT: EXT MTL

ASSEMBLY:

DESCRIPTION: TYPICAL EXTERIOR WALL NON-RATED



WALL PLACEMENT & DESCRIPTION

WALL TYPE

TAG EM S EX 0

FIRE RATING

WALL CODE TYPE

NAME: EM\_S\_0 (6\_NA)

COMMENT: EXT MTL

ASSEMBLY:

DESCRIPTION: NON-RATED EXTERIOR WALL AT POP-OUTS (NO GYP INSIDE)



WALL PLACEMENT & DESCRIPTION

WALL TYPE

TAG EM S EX 0

FIRE RATING

WALL CODE TYPE

NAME: EM\_S\_0 (8\_3KS)

COMMENT: EXT MTL

ASSEMBLY:

DESCRIPTION: EXTERIOR WALL WITH STUCCO ON BOTH SIDES NON-RATED



WALL PLACEMENT & DESCRIPTION

WALL TYPE

TAG EM S EX 0

FIRE RATING

WALL CODE TYPE

NAME: EM\_S\_0 (4\_3KS)

COMMENT: EXT MTL

ASSEMBLY:

DESCRIPTION: EXTERIOR WALL WITH STUCCO ON BOTH SIDES NON-RATED



WALL PLACEMENT & DESCRIPTION

WALL TYPE

TAG EM S EX 0

FIRE RATING

WALL CODE TYPE

NAME: EM\_S\_0 (6\_1KS)

COMMENT: EXT MTL

ASSEMBLY:

DESCRIPTION: EXTERIOR WALL WITH STUCCO ON BOTH SIDES NON-RATED



WALL PLACEMENT & DESCRIPTION

WALL TYPE

TAG EM S EX 0

FIRE RATING

WALL CODE TYPE

NAME: EM\_S\_0 (8\_1GB)

COMMENT: EXT MTL

ASSEMBLY:

DESCRIPTION: TYPICAL EXTERIOR WALL NON-RATED



WALL PLACEMENT & DESCRIPTION

WALL TYPE

TAG EM S EX 0

FIRE RATING

WALL CODE TYPE

NAME: EM\_S\_0 (8\_NA)

COMMENT: EXT MTL

ASSEMBLY:

DESCRIPTION: NON-RATED EXTERIOR WALL AT POP-OUTS (NO GYP INSIDE)



**ORB ASSEMBLIES**

EXTERIOR METAL STUD STRUCTURE WALLS

**04-EM-S-00**

DATE:  
04/04/20

U:\Andres\_Fernandez\Revise to HIVE\Wall Assemblies\ORB Assemblies\Split\_Walls\_2023.rvt 5/3/2023 3:05:25 PM



WALL PLACEMENT & DESCRIPTION

WALL TYPE

TAG **EM S EX 1**

FIRE RATING

WALL CODE TYPE

NAME: EM\_S\_1 (4\_1GB)

COMMENT: EXT MTL

ASSEMBLY:

DESCRIPTION: TYPICAL EXTERIOR WALL 1-HR RATED



WALL PLACEMENT & DESCRIPTION

WALL TYPE

TAG **EM S EX 1**

FIRE RATING

WALL CODE TYPE

NAME: EM\_S\_1 (4\_NA)

COMMENT: EXT MTL

ASSEMBLY:

DESCRIPTION: TYPICAL EXTERIOR WALL AT POP-OUTS (NO GYP INSIDE)



WALL PLACEMENT & DESCRIPTION

WALL TYPE

TAG **EM S EX 1**

FIRE RATING

WALL CODE TYPE

NAME: EM\_S\_1 (6\_1KS)

COMMENT: EXT MTL

ASSEMBLY:

DESCRIPTION: EXTERIOR WALL WITH STUCCO ON BOTH SIDES 1-HR RATED



WALL PLACEMENT & DESCRIPTION

WALL TYPE

TAG **EM S EX 1**

FIRE RATING

WALL CODE TYPE

NAME: EM\_S\_1 (6\_NA) Unit Separation

COMMENT: EXT MTL

ASSEMBLY:

DESCRIPTION: UNIT SEPARATION WALL WITH STUCCO



WALL PLACEMENT & DESCRIPTION

WALL TYPE

TAG **EM S EX 1**

FIRE RATING

WALL CODE TYPE

NAME: EM\_S\_1 (4\_1KS)

COMMENT: EXT MTL

ASSEMBLY:

DESCRIPTION: EXTERIOR WALL WITH STUCCO ON BOTH SIDES 1-HR RATED



WALL PLACEMENT & DESCRIPTION

WALL TYPE

TAG **EM S EX 1**

FIRE RATING

WALL CODE TYPE

NAME: EM\_S\_1 (4\_NA) Unit Separation

COMMENT: EXT MTL

ASSEMBLY:

DESCRIPTION: UNIT SEPARATION WALL WITH STUCCO



WALL PLACEMENT & DESCRIPTION

WALL TYPE

TAG **EM S EX 1**

FIRE RATING

WALL CODE TYPE

NAME: EM\_S\_1 (6\_3KS)

COMMENT: EXT MTL

ASSEMBLY:

DESCRIPTION: EXTERIOR WALL WITH STUCCO ON BOTH SIDES 1-HR RATED



WALL PLACEMENT & DESCRIPTION

WALL TYPE

TAG **EM S EX 1**

FIRE RATING

WALL CODE TYPE

NAME: EM\_S\_1 (8\_1GB)

COMMENT: EXT MTL

ASSEMBLY:

DESCRIPTION: TYPICAL EXTERIOR WALL 1-HR RATED



WALL PLACEMENT & DESCRIPTION

WALL TYPE

TAG **EM S EX 1**

FIRE RATING

WALL CODE TYPE

NAME: EM\_S\_1 (4\_3KS)

COMMENT: EXT MTL

ASSEMBLY:

DESCRIPTION: EXTERIOR WALL WITH STUCCO ON BOTH SIDES 1-HR RATED



WALL PLACEMENT & DESCRIPTION

WALL TYPE

TAG **EM S EX 1**

FIRE RATING

WALL CODE TYPE

NAME: EM\_S\_1 (6\_1GB)

COMMENT: EXT MTL

ASSEMBLY:

DESCRIPTION: TYPICAL EXTERIOR WALL 1-HR RATED



WALL PLACEMENT & DESCRIPTION

WALL TYPE

TAG **EM S EX 1**

FIRE RATING

WALL CODE TYPE

NAME: EM\_S\_1 (6\_NA)

COMMENT: EXT WD

ASSEMBLY:

DESCRIPTION: TYPICAL EXTERIOR WALL AT POP-OUTS (NO GYP INSIDE)



WALL PLACEMENT & DESCRIPTION

WALL TYPE

TAG **EM S EX 1**

FIRE RATING

WALL CODE TYPE

NAME: EM\_S\_1 (8\_1KS)

COMMENT: EXT MTL

ASSEMBLY:

DESCRIPTION: EXTERIOR WALL WITH STUCCO ON BOTH SIDES 1-HR RATED



**ORB ASSEMBLIES**

EXTERIOR METAL STUD STRUCTURE WALLS

**04-EM-S-01**

DATE: 04/04/20

J:\Andres\_Fernandez\Revise to\_HIVE\Wall\_Assemblies\ORB\_Assemblies\_Split\_Walls\_2023.rvt 5/3/2023 3:05:26 PM

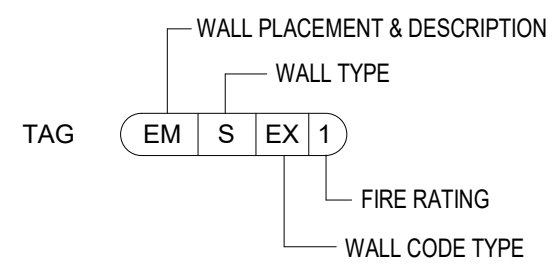

NAME: EM\_S\_1 (8\_3KS)  
 COMMENT: EXT MTL  
 ASSEMBLY:  
 DESCRIPTION: EXTERIOR WALL WITH STUCCO ON BOTH SIDES 1-HR RATED

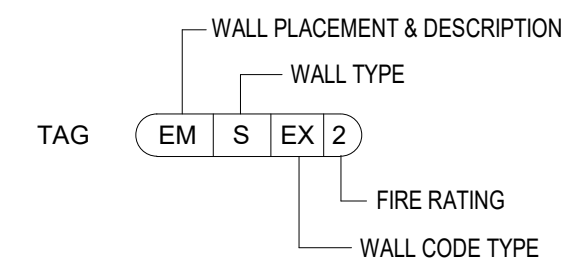

NAME: EM\_S\_2 (4\_2GB)  
 COMMENT: EXT MTL  
 ASSEMBLY:  
 DESCRIPTION: TYPICAL EXTERIOR WALL 2-HR RATED

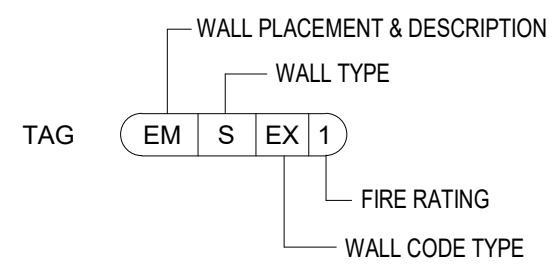

NAME: EM\_S\_1 (8\_NA)  
 COMMENT: EXT MTL  
 ASSEMBLY:  
 DESCRIPTION: TYPICAL EXTERIOR WALL AT POP-OUTS (NO GYP INSIDE)

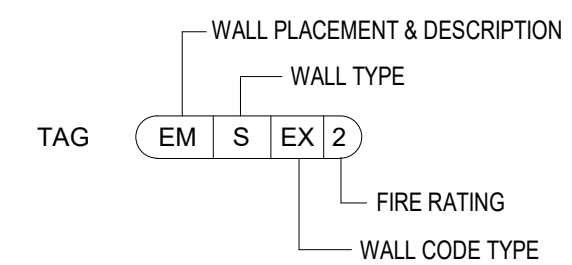

NAME: EM\_S\_2 (6\_2GB)  
 COMMENT: EXT MTL  
 ASSEMBLY:  
 DESCRIPTION: TYPICAL EXTERIOR WALL 2-HR RATED

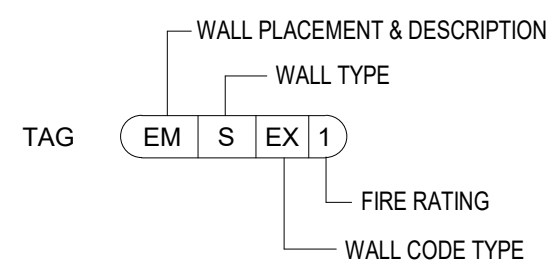

NAME: EM\_S\_1 (8\_NA) Unit Separation  
 COMMENT: EXT MTL  
 ASSEMBLY:  
 DESCRIPTION: UNIT SEPARATION WALL WITH STUCCO

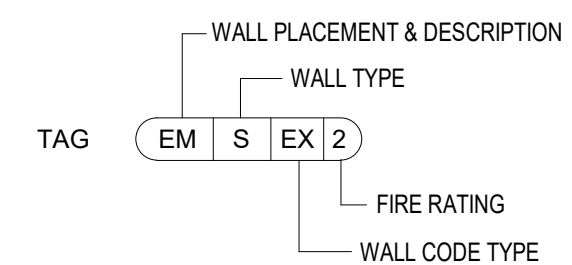

NAME: EM\_S\_2 (8\_2GB)  
 COMMENT: EXT MTL  
 ASSEMBLY:  
 DESCRIPTION: TYPICAL EXTERIOR WALL 2-HR RATED



**ORB ASSEMBLIES**  
 EXTERIOR METAL STUD STRUCTURE WALLS

**04-EM-S-02**

DATE:  
04/04/20

U:\Andres\_Fernandez\Revise to\_HIVE\Wall Assemblies\ORB Assemblies\_Split\_Walls\_2023.rvt 5/3/2023 3:05:26 PM

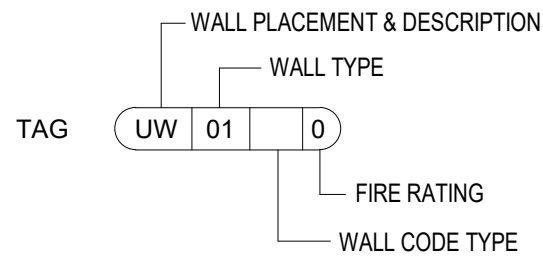

NAME: UW\_01\_0 (NA\_8x8x16\_NA)

COMMENT: CMU

ASSEMBLY: N/A

DESCRIPTION: TYPICAL CMU WALL  
NON-RATED

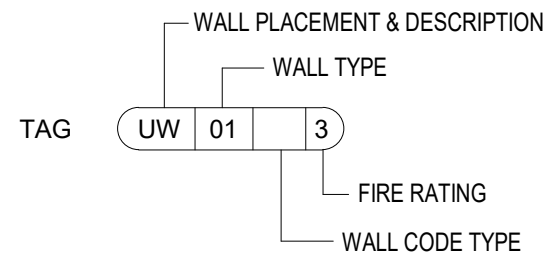

NAME: UW\_01\_3 (NA\_8x8x16\_NA)

COMMENT: CMU

ASSEMBLY: IBC 721.1 (2) 3-1.1/ 3-1.4

DESCRIPTION: TYPICAL CMU WALL-3-HR  
RATED

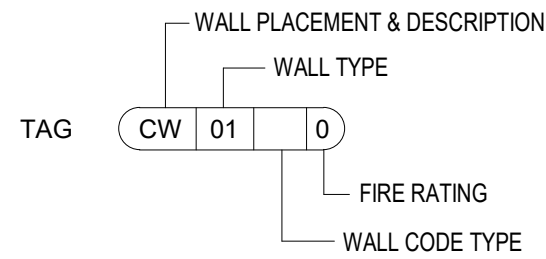

NAME: CW\_01\_0 (NA\_8\_NA)

COMMENT: CONC

ASSEMBLY: N/A

DESCRIPTION: TYPICAL CONCRETE WALL  
NON-RATED

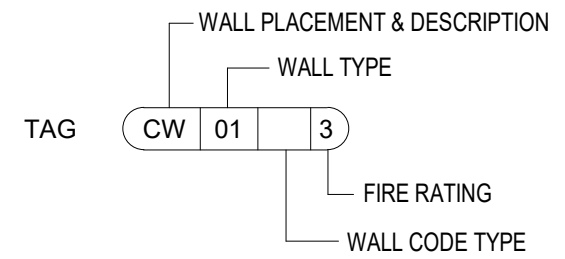

NAME: CW\_01\_3 (NA\_8\_NA)

COMMENT: CONC

ASSEMBLY: IBC 721.1 (2) 4-1.1

DESCRIPTION: TYPICAL CONCRETE WALL  
3-HR RATED

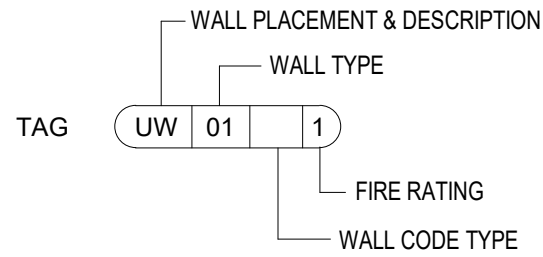

NAME: UW\_01\_1 (NA\_8x8x16\_NA)

COMMENT: CMU

ASSEMBLY: IBC 721.1 (2) 3-1.1/ 3-1.4

DESCRIPTION: TYPICAL CMU WALL  
1-HR-RATED

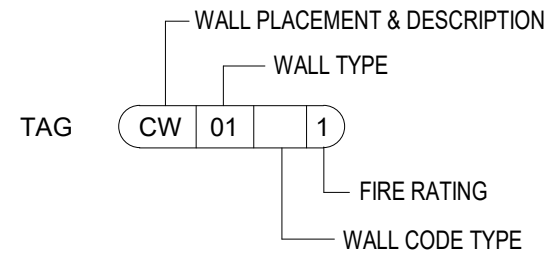

NAME: CW\_01\_1 (NA\_8\_NA)

COMMENT: CONC

ASSEMBLY: IBC 721.1 (2) 4-1.1

DESCRIPTION: TYPICAL CONCRETE WALL  
1-HR RATED

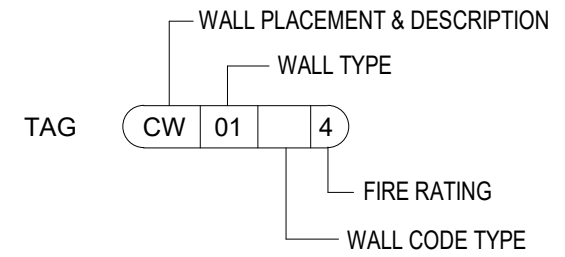

NAME: CW\_01\_4 (NA\_8\_NA)

COMMENT: CONC

ASSEMBLY: IBC 721.1 (2) 4-1.1

DESCRIPTION: TYPICAL CONCRETE WALL  
4-HR RATED

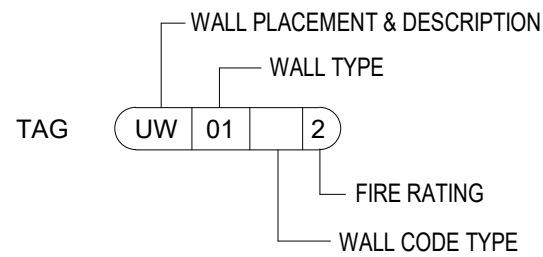

NAME: UW\_01\_2 (NA\_8x8x16\_NA)

COMMENT: CMU

ASSEMBLY: IBC 721.1 (2) 3-1.1/ 3-1.4

DESCRIPTION: TYPICAL CMU WALL  
2-HR-RATED

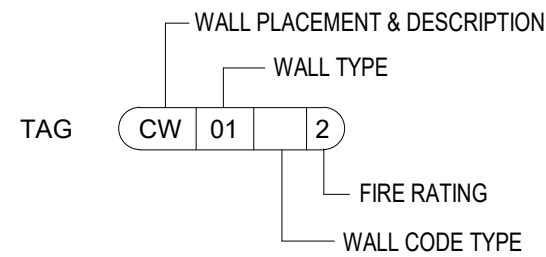

NAME: CW\_01\_2 (NA\_8\_NA)

COMMENT: CONC

ASSEMBLY: IBC 721.1 (2) 4-1.1

DESCRIPTION: TYPICAL CONCRETE WALL  
2-HR RATED



**ORB ASSEMBLIES**  
CMU & CONCRETE WALLS

**05-CONC-01**

DATE:  
04/04/20

U:\Andres\_Fernandez\Revise to\_HIVE\Wall\_Assemblies\ORB\_Assemblies\_Split\_Walls\_2023.rvt 5/3/2023 3:05:27 PM

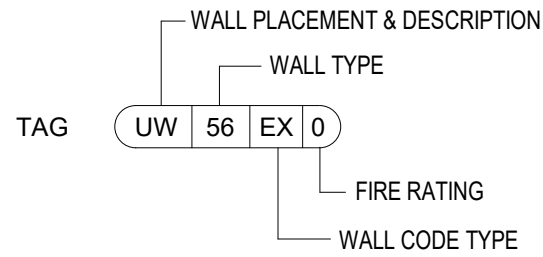
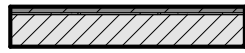

NAME: UWV\_56\_0 (BV\_8x8x16\_NA)

COMMENT: CMU-V

ASSEMBLY: IBC TABLE 721.1(2)NOs.

DESCRIPTION: 3-1.1-3-1.4  
CMU WALL WITH BRICK VENEER ON 1-SIDE NON-RATED

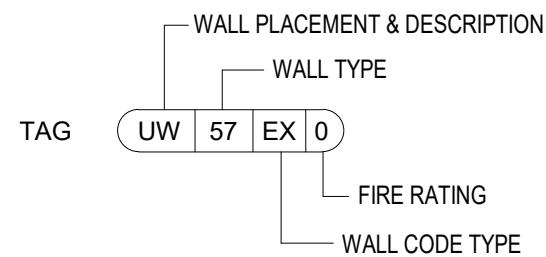
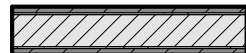

NAME: UWV\_57\_0 (BV\_8x8x16\_BV)

COMMENT: CMU-V

ASSEMBLY: IBC TABLE 721.1(2)NOs.

DESCRIPTION: 3-1.1-3-1.4  
CMU WALL WITH BRICK VENEER ON 2-SIDES NON-RATED

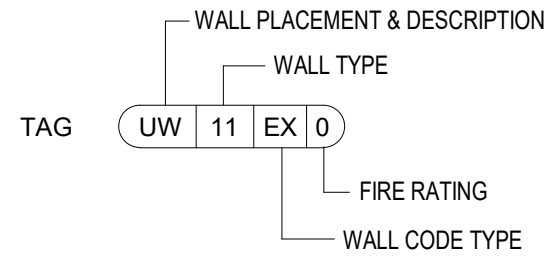
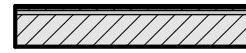

NAME: UWV\_11\_0 (3KS\_8x8x16\_NA)

COMMENT: CMU-S

ASSEMBLY: IBC TABLE 721.1(2)NOs.

DESCRIPTION: 3-1.1-3-1.4  
CMU WALL WITH STUCCO FINISH ON 1-SIDE NON-RATED

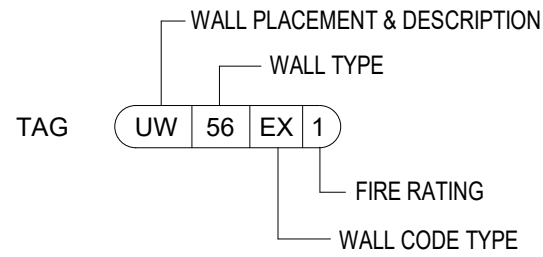
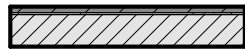

NAME: UWV\_56\_1 (BV\_8x8x16\_NA)

COMMENT: CMU-V

ASSEMBLY: IBC 721.1 (2) 3-1.1/ 3-1.4

DESCRIPTION: CMU WALL WITH BRICK VENEER ON 1-SIDE 1-HR RATED

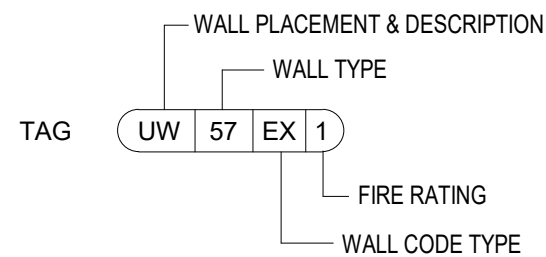
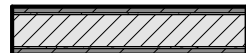

NAME: UWV\_57\_1 (BV\_8x8x16\_BV)

COMMENT: CMU-V

ASSEMBLY: IBC 721.1 (2) 3-1.1/ 3-1.4

DESCRIPTION: CMU WALL WITH BRICK VENEER 2-SIDES 1-HR RATED

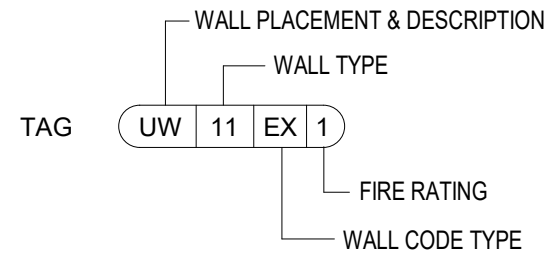
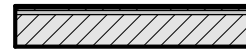

NAME: UWV\_11\_1 (3KS\_8x8x16\_NA)

COMMENT: CMU-S

ASSEMBLY: IBC TABLE 721.1(2)NOs.

DESCRIPTION: 3-1.1-3-1.4  
CMU WALL WITH STUCCO FINISH ON 1-SIDE 1HR-RATED

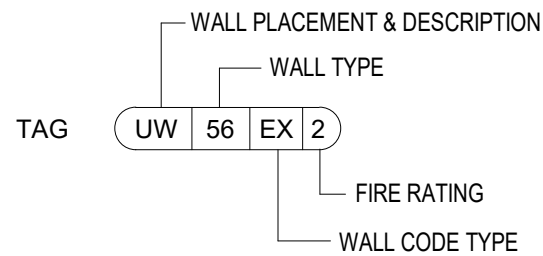
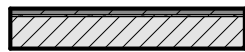

NAME: UWV\_56\_2 (BV\_8x8x16\_NA)

COMMENT: CMU-V

ASSEMBLY: IBC 721.1 (2) 3-1.1/ 3-1.4

DESCRIPTION: CMU WALL WITH BRICK VENEER ON 1-SIDE 2-HR RATED

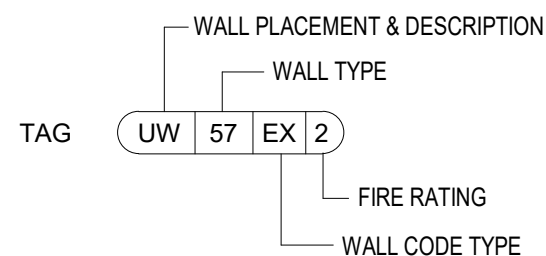
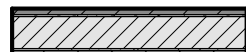

NAME: UWV\_57\_2 (BV\_8x8x16\_BV)

COMMENT: CMU-V

ASSEMBLY: IBC 721.1 (2) 3-1.1/ 3-1.4

DESCRIPTION: CMU WALL WITH BRICK VENEER 2-SIDES 2-HR RATED

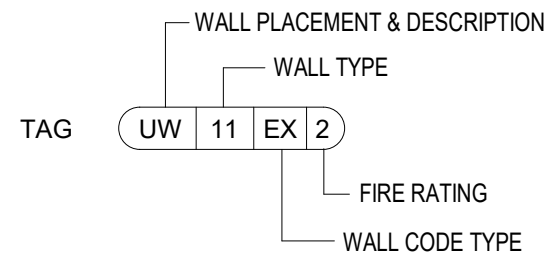
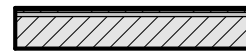

NAME: UWV\_11\_2 (3KS\_8x8x16\_NA)

COMMENT: CMU-S

ASSEMBLY: IBC TABLE 721.1(2)NOs.

DESCRIPTION: 3-1.1-3-1.4  
CMU WALL WITH STUCCO FINISH ON 1-SIDE 2HR-RATED



**ORB ASSEMBLIES**  
CMU WITH VENEER

**05-CONC-02**

DATE:  
04/04/20

5/3/2023 3:05:28 PM  
U:\Andres\_Fernandez\Revise to\_HIVE\Wall\_Assemblies\ORB\_Assemblies\_Split\_Walls\_2023.rvt



**ORB ASSEMBLIES**  
**CONCRETE WALLS WITH VENEER**

**05-CONC-03**

DATE:  
04/04/20

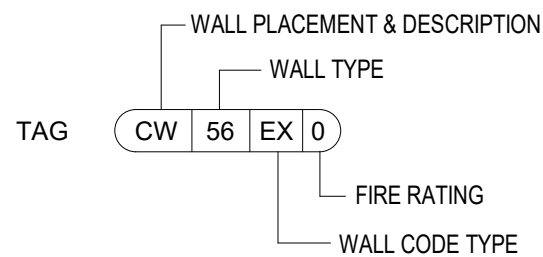
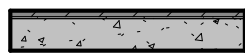

NAME: CWV\_56\_0 (BV\_8\_NA)

COMMENT: CONC-V

ASSEMBLY: IBC TABLE 721.1(2) 4-1.1

DESCRIPTION: CONCRETE WALL WITH BRICK VENEER ON 1-SIDE NON-RATED

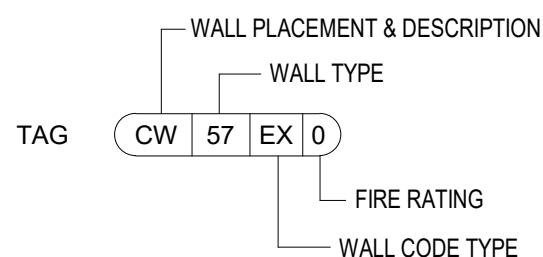

NAME: CWV\_57\_0 (BV\_8\_BV)

COMMENT: CONC-V

ASSEMBLY: IBC TABLE 721.1(2) 4-1.1

DESCRIPTION: CONCRETE WALL WITH BRICK VENEER ON 2-SIDES NON-RATED

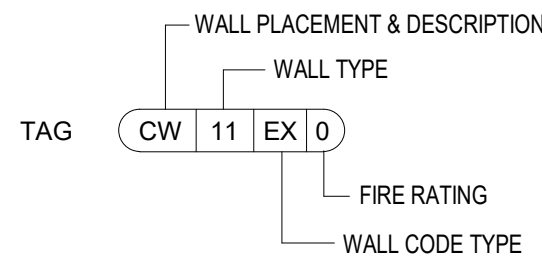
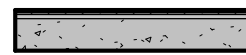

NAME: CWV\_11\_0 (3KS\_8\_NA)

COMMENT: CONC-V

ASSEMBLY: IBC TABLE 721.1(2) 4-1.1

DESCRIPTION: CONCRETE WALL WITH STUCCO FINISH ON 1-SIDE NON-RATED

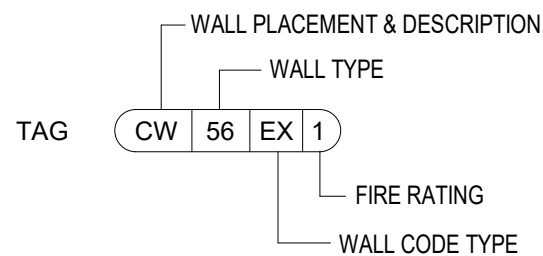
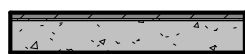

NAME: CWV\_56\_1 (BV\_8\_NA)

COMMENT: CONC-V

ASSEMBLY: IBC 721.1 (2) 4-1.1

DESCRIPTION: CONCRETE WALL WITH BRICK VENEER 1-SIDE 1-HR RATED

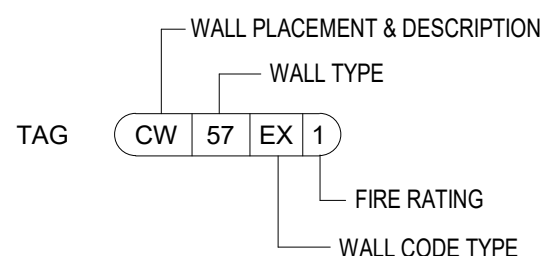
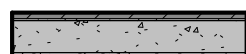

NAME: CWV\_57\_1 (BV\_8\_BV)

COMMENT: CONC-V

ASSEMBLY: IBC 721.1 (2) 4-1.1

DESCRIPTION: CONCRETE WALL WITH BRICK VENEER 2-SIDES 1-HR RATED

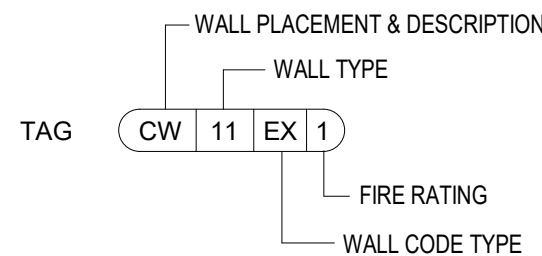
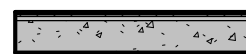

NAME: CWV\_11\_1 (3KS\_8\_NA)

COMMENT: CONC-V

ASSEMBLY: IBC TABLE 721.1(2) 4-1.1

DESCRIPTION: CONCRETE WALL WITH STUCCO FINISH ON 1-SIDE 1HR-RATED

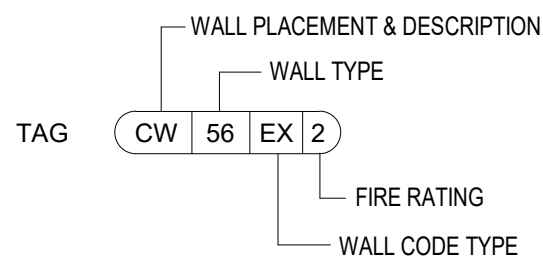
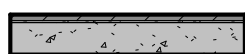

NAME: CWV\_11\_2 (BV\_8\_NA)

COMMENT: CONC-V

ASSEMBLY: IBC 721.1 (2) 4-1.1

DESCRIPTION: CONCRETE WALL WITH BRICK VENEER 1-SIDE 2-HR RATED

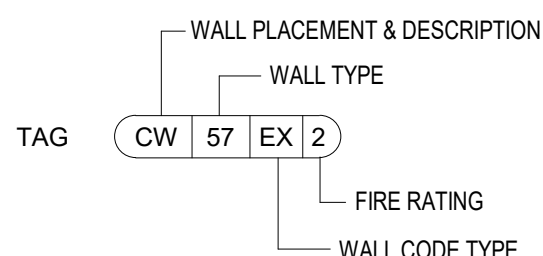
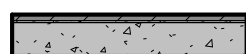

NAME: CWV\_57\_2 (BV\_8\_BV)

COMMENT: CONC-V

ASSEMBLY: IBC 721.1 (2) 4-1.1

DESCRIPTION: CONCRETE WALL WITH BRICK VENEER 2-SIDES 2-HR RATED

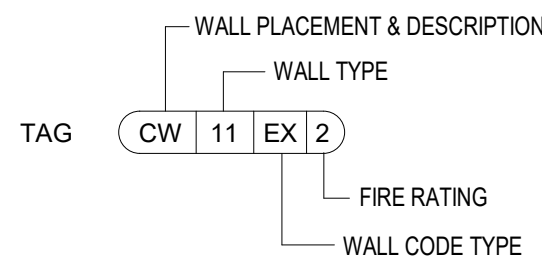

NAME: CWV\_11\_2 (3KS\_8\_NA)

COMMENT: CONC-V

ASSEMBLY: IBC TABLE 721.1(2) 4-1.1

DESCRIPTION: CONCRETE WALL WITH STUCCO FINISH ON 1-SIDE 2HR-RATED



SHAFT WALLS

5/3/2023 3:05:28 PM

J:\Andres\_Fernandez\Revise to HIVE\Wall Assemblies\ORB Assemblies\_Split\_Walls\_2023.rvt



ORB ASSEMBLIES

FIRE WALLS AND SHAFT WALLS

06-FW\*SW

DATE:  
03/01/23

WALL PLACEMENT & DESCRIPTION

WALL TYPE

TAG FW 21 FW 2

FIRE RATING

WALL CODE TYPE

NAME: FW\_21\_2 (Liner 2GB 1")

COMMENT: LINER

ASSEMBLY: UL U347

DESCRIPTION: FIRE WALL 2" LINER 2-HR RATED AT INTERIOR 2x WOOD WALL ON EACH SIDE

WALL PLACEMENT & DESCRIPTION

WALL TYPE

TAG FW 24 FW 3

FIRE RATING

WALL CODE TYPE

NAME: FW\_24\_3 (Liner 2GB 1")

COMMENT: LINER

ASSEMBLY: UL U454

DESCRIPTION: FIRE WALL 2" LINER 3-HR RATED AT EXTERIOR 2x WOOD WALL ON EACH SIDE

INTERIOR SHAFT

WALL PLACEMENT & DESCRIPTION

WALL TYPE

TAG SH 01 FB 2

FIRE RATING

WALL CODE TYPE

NAME: SH\_01\_2 (Liner 2GB 1")

COMMENT: LINER

ASSEMBLY: UL U347

DESCRIPTION: FIRE WALL 2" LINER 2-HR RATED AT INTERIOR 2x WOOD WALL EXTERIOR SIDE

WALL PLACEMENT & DESCRIPTION

WALL TYPE

TAG FW 22 FW 2

FIRE RATING

WALL CODE TYPE

NAME: FW\_22\_2 (Liner 2GB 1")

COMMENT: LINER

ASSEMBLY: UL U347

DESCRIPTION: FIRE WALL 2" LINER 2-HR RATED AT EXTERIOR 2x WOOD WALL ON EACH SIDE

WALL PLACEMENT & DESCRIPTION

WALL TYPE

TAG FW 25 FW 2

FIRE RATING

WALL CODE TYPE

NAME: FW\_25\_2 (Liner 2GB 1")

COMMENT: LINER

ASSEMBLY: UL U347

DESCRIPTION: FIRE WALL 2" LINER 2-HR RATED AT INTERIOR 2x METAL WALL ON EACH SIDE

WALL PLACEMENT & DESCRIPTION

WALL TYPE

TAG SH 02 FB 2

FIRE RATING

WALL CODE TYPE

NAME: SH\_02\_2 (Liner 2GB 4 1"GB) SHAFT

COMMENT: LINER

ASSEMBLY: UL U428

DESCRIPTION: SHAFT WALL 2.5" STUDS 2-HR RATED

WALL PLACEMENT & DESCRIPTION

WALL TYPE

TAG FW 23 FW 3

FIRE RATING

WALL CODE TYPE

NAME: FW\_23\_3 (Liner 2GB 1")

COMMENT: LINER

ASSEMBLY: UL W454

DESCRIPTION: FIRE WALL 2" LINER 3-HR RATED AT EXTERIOR 2x WOOD WALL ON EACH SIDE

WALL PLACEMENT & DESCRIPTION

WALL TYPE

TAG FW 26 FW 2

FIRE RATING

WALL CODE TYPE

NAME: FW\_26\_2 (Liner 2GB 1")

COMMENT: LINER

ASSEMBLY: UL W454

DESCRIPTION: FIRE WALL 2" LINER 3-HR RATED AT EXTERIOR 2x METAL WALL ON EACH SIDE

WALL PLACEMENT & DESCRIPTION

WALL TYPE

TAG SH 04 FB 2

FIRE RATING

WALL CODE TYPE

NAME: SH\_04\_2 (Liner 2GB 4 1"GB) SHAFT

COMMENT: LINER

ASSEMBLY: UL U428

DESCRIPTION: SHAFT WALL 4" STUDS 2-HR RATED

5/3/2023 3:05:29 PM  
U:\Andres\_Fernandez\Revise to\_HIVE\Wall\_Assemblies\ORB\_Assemblies\_Split\_Walls\_2023.rvt

RESILIENT CHANNEL  
W/ 1 LAYER OF GYPSUM BOARD



WALL PLACEMENT & DESCRIPTION

WALL TYPE

TAG IW 02 FP 1

FIRE RATING

WALL CODE TYPE

NAME: IW\_02\_1 (1GB\_RS\_4\_1GB) Corridor  
COMMENT: INT WD  
ASSEMBLY: WP 3242  
DESCRIPTION: TYPICAL 2x4 CORRIDOR WALL 1-HR RATED W/ RESILIENT CHANNEL - 54 STC

(2) LAYERS OF GYPSUM BOARD ON CORRIDOR SIDE AND (1) LAYER ON UNIT SIDE



WALL PLACEMENT & DESCRIPTION

WALL TYPE

TAG IW 02 FP 1

FIRE RATING

WALL CODE TYPE

NAME: IW\_02\_1 (2GB\_4\_1GB) Corridor  
COMMENT: INT WD  
ASSEMBLY: IBC 722.6 (2018)  
DESCRIPTION: TYPICAL 2x4 CORRIDOR WALL 1-HR RATED - 50 STC



WALL PLACEMENT & DESCRIPTION

WALL TYPE

TAG IW 02 FP 1

FIRE RATING

WALL CODE TYPE

NAME: IW\_02\_1 (1GB\_RS\_6\_1GB) Corridor  
COMMENT: INT WD  
ASSEMBLY: WP 3242  
DESCRIPTION: TYPICAL 2x6 CORRIDOR WALL 1-HR RATED W/ RESILIENT CHANNEL - 54 STC



WALL PLACEMENT & DESCRIPTION

WALL TYPE

TAG IW 02 FP 1

FIRE RATING

WALL CODE TYPE

NAME: IW\_02\_1 (2GB\_6\_1GB) Corridor  
COMMENT: INT WD  
ASSEMBLY: IBC 722.6 (2018)  
DESCRIPTION: TYPICAL 2x6 CORRIDOR WALL 1-HR RATED - 50 STC



WALL PLACEMENT & DESCRIPTION

WALL TYPE

TAG IW 02 FP 1

FIRE RATING

WALL CODE TYPE

NAME: IW\_02\_1 (1GB\_RS\_8\_1GB) Corridor  
COMMENT: INT WD  
ASSEMBLY: WP 3242  
DESCRIPTION: TYPICAL 2x8 CORRIDOR WALL 1-HR RATED W/ RESILIENT CHANNEL - 54 STC



WALL PLACEMENT & DESCRIPTION

WALL TYPE

TAG IW 02 FP 1

FIRE RATING

WALL CODE TYPE

NAME: IW\_02\_1 (2GB\_8\_1GB) Corridor  
COMMENT: INT WD  
ASSEMBLY: IBC 722.6 (2018)  
DESCRIPTION: TYPICAL 2x8 CORRIDOR WALL 1-HR RATED - 50 STC



WALL PLACEMENT & DESCRIPTION

WALL TYPE

TAG IW 02 FP 1

FIRE RATING

WALL CODE TYPE

NAME: IW\_02\_1 (2GB\_ALT\_1GB) Corridor  
COMMENT: INT WD  
ASSEMBLY: IBC 722.6 (2018)  
DESCRIPTION: ALTERNATING STUDS @ CORRIDOR WALL 1-HR RATED - 50 STC



**ORB ASSEMBLIES**  
**CORRIDOR WOOD WALLS**

**07-IW02**

DATE:  
03/01/23

ENHANCED ACOUSTIC

ENHANCED ACOUSTIC

U:\Andres\_Fernandez\Revise to HIVE\Wall Assemblies\ORB Assemblies\_Split\_Walls\_2023.rvt 5/3/2023 3:05:30 PM



WALL PLACEMENT & DESCRIPTION

WALL TYPE

TAG: IW 01 FB 1

FIRE RATING

WALL CODE TYPE

NAME: IW\_01\_1 (1GB\_4\_NA) Unit Separation  
 COMMENT: INT WD  
 ASSEMBLY: WP 5512  
 DESCRIPTION: TYPICAL 2x4 UNIT SEPARATION WALL 1-HR RATED



WALL PLACEMENT & DESCRIPTION

WALL TYPE

TAG: IW 01 FB 1

FIRE RATING

WALL CODE TYPE

NAME: IW\_01\_1 (1GB\_4\_NA) Unit Separation - Acoustic  
 COMMENT: INT WD  
 ASSEMBLY: ESR-1338  
 DESCRIPTION: TYPICAL 2x4 UNIT SEPARATION WALL 1-HR RATED - ENHANCED ACOUSTICS, STC 67



WALL PLACEMENT & DESCRIPTION

WALL TYPE

TAG: IM 01 FB 1

FIRE RATING

WALL CODE TYPE

NAME: IM\_01\_1 (1GB\_4\_NA) Unit Separation  
 COMMENT: INT MTL  
 ASSEMBLY: UL U493  
 DESCRIPTION: TYPICAL 3-5/8" UNIT SEPARATION WALL 1-HR RATED



WALL PLACEMENT & DESCRIPTION

WALL TYPE

TAG: IM 01 FB 1

FIRE RATING

WALL CODE TYPE

NAME: IM\_01\_1 (1GB\_4\_NA) Unit Separation - Acoustic  
 COMMENT: INT MTL  
 ASSEMBLY: WP 0953  
 DESCRIPTION: TYPICAL 3-5/8" UNIT SEPARATION WALL 1-HR RATED - ENHANCED ACOUSTICS, STC 60-64



WALL PLACEMENT & DESCRIPTION

WALL TYPE

TAG: IW 01 FB 1

FIRE RATING

WALL CODE TYPE

NAME: IW\_01\_1 (1GB\_6\_NA) Unit Separation  
 COMMENT: INT WD  
 ASSEMBLY: WP 5512  
 DESCRIPTION: TYPICAL 2x6 UNIT SEPARATION WALL 1-HR RATED



WALL PLACEMENT & DESCRIPTION

WALL TYPE

TAG: IW 01 FB 1

FIRE RATING

WALL CODE TYPE

NAME: IW\_01\_1 (1GB\_6\_NA) Unit Separation - Acoustics  
 COMMENT: INT WD  
 ASSEMBLY: ESR 1338  
 DESCRIPTION: TYPICAL 2x6 UNIT SEPARATION WALL 1-HR RATED - ENHANCED ACOUSTICS STC 67



WALL PLACEMENT & DESCRIPTION

WALL TYPE

TAG: IM 01 FB 1

FIRE RATING

WALL CODE TYPE

NAME: IM\_01\_1 (1GB\_6\_NA) Unit Separation  
 COMMENT: INT MTL  
 ASSEMBLY: UL U493  
 DESCRIPTION: TYPICAL 6" UNIT SEPARATION WALL 1-HR RATED - ENHANCED ACOUSTICS, STC 60-64



WALL PLACEMENT & DESCRIPTION

WALL TYPE

TAG: IM 01 FB 1

FIRE RATING

WALL CODE TYPE

NAME: IM\_01\_1 (1GB\_6\_NA) Unit Separation - Acoustic  
 COMMENT: INT MTL  
 ASSEMBLY: WP 0953  
 DESCRIPTION: TYPICAL 6" UNIT SEPARATION WALL 1-HR RATED - ENHANCED ACOUSTICS, STC 60-64



WALL PLACEMENT & DESCRIPTION

WALL TYPE

TAG: IW 01 FB 1

FIRE RATING

WALL CODE TYPE

NAME: IW\_01\_1 (1GB\_8\_NA) Unit Separation  
 COMMENT: INT WD  
 ASSEMBLY: WP 5512  
 DESCRIPTION: TYPICAL 2x8 UNIT SEPARATION WALL 1-HR RATED



WALL PLACEMENT & DESCRIPTION

WALL TYPE

TAG: IW 01 FB 1

FIRE RATING

WALL CODE TYPE

NAME: IW\_01\_1 (1GB\_8\_NA) Unit Separation - Acoustics  
 COMMENT: INT WD  
 ASSEMBLY: ESR 1338  
 DESCRIPTION: TYPICAL 2x8 UNIT SEPARATION WALL 1-HR RATED - ENHANCED ACOUSTICS, STC 67



WALL PLACEMENT & DESCRIPTION

WALL TYPE

TAG: IM 01 FB 1

FIRE RATING

WALL CODE TYPE

NAME: IM\_01\_1 (1GB\_8\_NA) Unit Separation  
 COMMENT: INT MTL  
 ASSEMBLY: UL U493  
 DESCRIPTION: TYPICAL 8" UNIT SEPARATION WALL 1-HR RATED



WALL PLACEMENT & DESCRIPTION

WALL TYPE

TAG: IM 01 FB 1

FIRE RATING

WALL CODE TYPE

NAME: IM\_01\_1 (1GB\_8\_NA) Unit Separation - Acoustic  
 COMMENT: INT MTL  
 ASSEMBLY: WP 0953  
 DESCRIPTION: TYPICAL 8" UNIT SEPARATION WALL 1-HR RATED - ENHANCED ACOUSTICS, STC 60-64



**ORB ASSEMBLIES**  
 INTERIOR WOOD FRAMED WALLS

**07-IW/IM-01**

DATE:  
03/01/23

5/3/2023 3:05:30 PM  
U:\Andres\_Fernandez\Revise to HIVE\Wall Assemblies\ORB Assemblies\_Split\_Walls\_2023.rvt

**RESILIENT CHANNEL W/ 1 LAYER OF GYPSUM BOARD**



WALL PLACEMENT & DESCRIPTION

WALL TYPE

TAG: IM 02 FB 1

FIRE RATING

WALL CODE TYPE

NAME: IM\_02\_1 (1GB\_RS\_4\_1GB) Corridor

COMMENT: INT MTL

ASSEMBLY: UL 419

DESCRIPTION: TYPICAL 3 5/8" CORRIDOR WALL 1-HR RATED W/ RESILIENT CHANNEL - NON LOAD BEARING

**RESILIENT CHANNEL W/ NO GYP ON INTERIOR SIDE**



WALL PLACEMENT & DESCRIPTION

WALL TYPE

TAG: IM 02 FB 1

FIRE RATING

WALL CODE TYPE

NAME: IM\_02\_1 (1GB\_RS\_4\_NA) Corridor

COMMENT: INT MTL

ASSEMBLY: UL 419

DESCRIPTION: TYPICAL 3 5/8" CORRIDOR WALL 1-HR RATED W/ RESILIENT CHANNEL - NON LOAD BEARING

**(2) LAYERS OF GYPSUM BOARD ON EXTERIOR SIDE AND (1) LAYER ON INTERIOR SIDE**



WALL PLACEMENT & DESCRIPTION

WALL TYPE

TAG: IM 02 FB 1

FIRE RATING

WALL CODE TYPE

NAME: IM\_02\_1 (2GB\_4\_1GB) Corridor

COMMENT: INT MTL

ASSEMBLY: WP 1052

DESCRIPTION: TYPICAL 3-5/8" CORRIDOR WALL 1-HR RATED

**(2) LAYERS OF GYPSUM BOARD ON EXTERIOR SIDE AND NO GYPSUM ON INTERIOR SIDE**



WALL PLACEMENT & DESCRIPTION

WALL TYPE

TAG: IM 02 FB 1

FIRE RATING

WALL CODE TYPE

NAME: IM\_02\_1 (2GB\_4\_NA) Corridor

COMMENT: INT MTL

ASSEMBLY: WP 1052

DESCRIPTION: TYPICAL 3-5/8" CORRIDOR WALL NO-GYP INSIDE 1-HR RATED



WALL PLACEMENT & DESCRIPTION

WALL TYPE

TAG: IM 02 FB 1

FIRE RATING

WALL CODE TYPE

NAME: IM\_02\_1 (1GB\_RS\_6\_1GB) Corridor

COMMENT: INT WD

ASSEMBLY: UL 419

DESCRIPTION: TYPICAL 6" METAL STUD CORRIDOR WALL 1-HR RATED W/ RESILIENT CHANNEL - NON LOAD BEARING



WALL PLACEMENT & DESCRIPTION

WALL TYPE

TAG: IM 02 FB 1

FIRE RATING

WALL CODE TYPE

NAME: IM\_02\_1 (1GB\_RS\_6\_NA) Corridor

COMMENT: INT WD

ASSEMBLY: UL 419

DESCRIPTION: TYPICAL 6" METAL STUD CORRIDOR WALL 1-HR RATED W/ RESILIENT CHANNEL - NON LOAD BEARING



WALL PLACEMENT & DESCRIPTION

WALL TYPE

TAG: IM 02 FB 1

FIRE RATING

WALL CODE TYPE

NAME: IM\_02\_1 (2GB\_6\_1GB) Corridor

COMMENT: INT MTL

ASSEMBLY: WP 1052

DESCRIPTION: TYPICAL 6" CORRIDOR WALL 1-HR RATED



WALL PLACEMENT & DESCRIPTION

WALL TYPE

TAG: IM 02 FB 1

FIRE RATING

WALL CODE TYPE

NAME: IM\_02\_1 (2GB\_6\_NA) Corridor

COMMENT: INT MTL

ASSEMBLY: WP 1052

DESCRIPTION: TYPICAL 6" CORRIDOR WALL 1-HR RATED



WALL PLACEMENT & DESCRIPTION

WALL TYPE

TAG: IM 02 FB 1

FIRE RATING

WALL CODE TYPE

NAME: IM\_02\_1 (1GB\_RS\_8\_1GB) Corridor

COMMENT: INT WD

ASSEMBLY: UL 419

DESCRIPTION: TYPICAL 8" METAL STUD CORRIDOR WALL 1-HR RATED W/ RESILIENT CHANNEL - NON LOAD BEARING



WALL PLACEMENT & DESCRIPTION

WALL TYPE

TAG: IM 02 FB 1

FIRE RATING

WALL CODE TYPE

NAME: IM\_02\_1 (1GB\_RS\_8\_NA) Corridor

COMMENT: INT WD

ASSEMBLY: UL 419

DESCRIPTION: TYPICAL 8" METAL STUD CORRIDOR WALL 1-HR RATED W/ RESILIENT CHANNEL - NON LOAD BEARING



WALL PLACEMENT & DESCRIPTION

WALL TYPE

TAG: IM 02 FB 1

FIRE RATING

WALL CODE TYPE

NAME: IM\_02\_1 (2GB\_8\_1GB) Corridor

COMMENT: INT MTL

ASSEMBLY: WP 1052

DESCRIPTION: TYPICAL 8" CORRIDOR WALL 1-HR RATED



WALL PLACEMENT & DESCRIPTION

WALL TYPE

TAG: IM 02 FB 1

FIRE RATING

WALL CODE TYPE

NAME: IM\_02\_1 (2GB\_8\_NA) Corridor

COMMENT: INT MTL

ASSEMBLY: WP 1052

DESCRIPTION: TYPICAL 8" CORRIDOR WALL 1-HR RATED



**ORB ASSEMBLIES**  
**CORRIDOR METAL WALLS**

**07-IW/IM-02**

DATE:  
03/01/23

U:\Andres\_Fernandez\Revise to HIVE\Wall Assemblies\ORB Assemblies\_Split\_Walls\_2023.rvt 5/3/2023 3:05:31 PM

WALL PLACEMENT & DESCRIPTION

WALL TYPE

TAG: IW 03 - 0

FIRE RATING

WALL CODE TYPE

NAME: IW\_03\_0 (1GB\_4\_1GB)  
 COMMENT: INT WD  
 ASSEMBLY: N/A  
 DESCRIPTION: TYPICAL 2x4 INTERIOR WALL  
 NON-RATED

WALL PLACEMENT & DESCRIPTION

WALL TYPE

TAG: IW 03 FB 1

FIRE RATING

WALL CODE TYPE

NAME: IW\_03\_1 (1GB\_4\_1GB)  
 COMMENT: INT WD  
 ASSEMBLY: UL U305  
 DESCRIPTION: TYPICAL 2x4 INTERIOR WALL  
 1-HR RATED

WALL PLACEMENT & DESCRIPTION

WALL TYPE

TAG: IM 03 - 0

FIRE RATING

WALL CODE TYPE

NAME: IM\_03\_0 (1GB\_4\_1GB)  
 COMMENT: INT MTL  
 ASSEMBLY: UL U423  
 DESCRIPTION: TYPICAL 3-5/8" INTERIOR WALL  
 NON-RATED

WALL PLACEMENT & DESCRIPTION

WALL TYPE

TAG: IM 03 FB 1

FIRE RATING

WALL CODE TYPE

NAME: IM\_03\_1 (1GB\_4\_1GB)  
 COMMENT: INT MTL  
 ASSEMBLY: UL U423  
 DESCRIPTION: TYPICAL 3-5/8" INTERIOR WALL  
 1-HR RATED

WALL PLACEMENT & DESCRIPTION

WALL TYPE

TAG: IW 03 - 0

FIRE RATING

WALL CODE TYPE

NAME: IW\_03\_0 (1GB\_6\_1GB)  
 COMMENT: INT WD  
 ASSEMBLY: N/A  
 DESCRIPTION: TYPICAL 2x6 INTERIOR WALL  
 NON-RATED

WALL PLACEMENT & DESCRIPTION

WALL TYPE

TAG: IW 03 FB 1

FIRE RATING

WALL CODE TYPE

NAME: IW\_03\_1 (1GB\_6\_1GB)  
 COMMENT: INT WD  
 ASSEMBLY: UL U305  
 DESCRIPTION: TYPICAL 2x6 INTERIOR WALL  
 1-HR RATED

WALL PLACEMENT & DESCRIPTION

WALL TYPE

TAG: IM 03 - 0

FIRE RATING

WALL CODE TYPE

NAME: IM\_03\_0 (1GB\_6\_1GB)  
 COMMENT: INT MTL  
 ASSEMBLY: UL U423  
 DESCRIPTION: TYPICAL 6" INTERIOR WALL  
 NON-RATED

WALL PLACEMENT & DESCRIPTION

WALL TYPE

TAG: IM 03 FB 1

FIRE RATING

WALL CODE TYPE

NAME: IM\_03\_1 (1GB\_6\_1GB)  
 COMMENT: INT MTL  
 ASSEMBLY: UL U423  
 DESCRIPTION: TYPICAL 6" INTERIOR WALL  
 1-HR RATED

WALL PLACEMENT & DESCRIPTION

WALL TYPE

TAG: IW 03 - 0

FIRE RATING

WALL CODE TYPE

NAME: IW\_03\_0 (1GB\_8\_1GB)  
 COMMENT: INT WD  
 ASSEMBLY: N/A  
 DESCRIPTION: TYPICAL 2x8 INTERIOR WALL  
 NON-RATED

WALL PLACEMENT & DESCRIPTION

WALL TYPE

TAG: IW 03 FB 1

FIRE RATING

WALL CODE TYPE

NAME: IW\_03\_1 (1GB\_8\_1GB)  
 COMMENT: INT WD  
 ASSEMBLY: UL U305  
 DESCRIPTION: TYPICAL 2x8 INTERIOR WALL  
 1-HR RATED

WALL PLACEMENT & DESCRIPTION

WALL TYPE

TAG: IM 03 - 0

FIRE RATING

WALL CODE TYPE

NAME: IM\_03\_0 (1GB\_8\_1GB)  
 COMMENT: INT MTL  
 ASSEMBLY: UL U423  
 DESCRIPTION: TYPICAL 6" INTERIOR WALL  
 NON-RATED

WALL PLACEMENT & DESCRIPTION

WALL TYPE

TAG: IM 03 FB 1

FIRE RATING

WALL CODE TYPE

NAME: IM\_03\_1 (1GB\_8\_1GB)  
 COMMENT: INT MTL  
 ASSEMBLY: UL U423  
 DESCRIPTION: TYPICAL 8" INTERIOR WALL  
 1-HR RATED



**ORB ASSEMBLIES**  
**INTERIOR WALLS**

**07-IW/IM-03**

DATE:  
 03/01/23

U:\Andres\_Fernandez\Revise to HIVE\Wall Assemblies\ORB Assemblies\_Split\_Walls\_2023.rvt 5/3/2023 3:05:32 PM

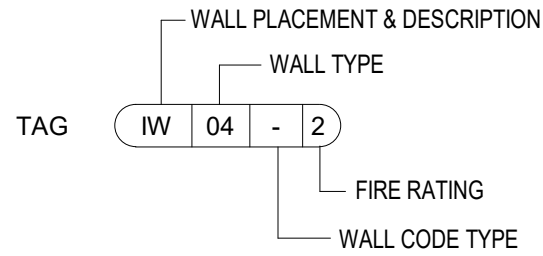

NAME: IW\_04\_2 (2GB\_4\_2GB)

COMMENT: INT WD

ASSEMBLY: UL U301

DESCRIPTION: TYPICAL 2x4 INTERIOR WALL  
2-HR RATED

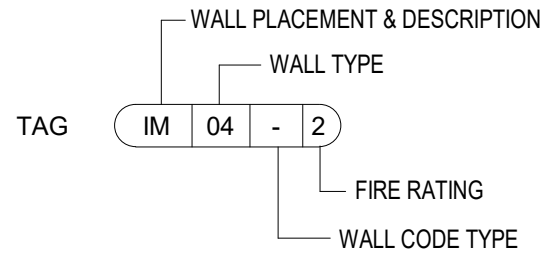

NAME: IM\_04\_2 (2GB\_4\_2GB)

COMMENT: INT MTL

ASSEMBLY: B2010

DESCRIPTION: TYPICAL 3-5/8" INTERIOR WALL  
2-HR RATED

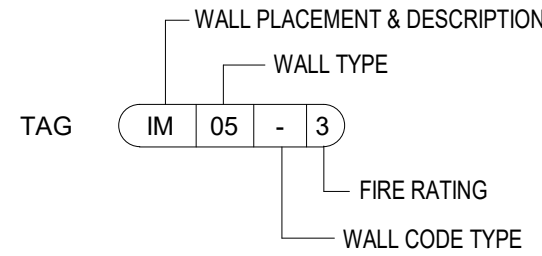

NAME: IM\_05\_3 (3GB\_4\_3GB)

COMMENT: INT MTL

ASSEMBLY: B2010

DESCRIPTION: TYPICAL 3-5/8" INTERIOR WALL  
3-HR RATED

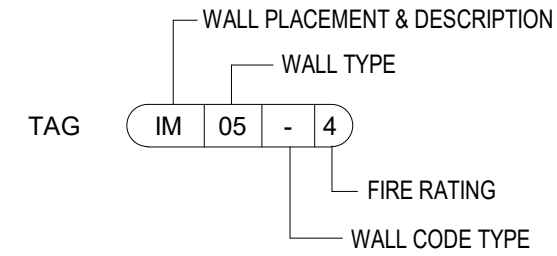

NAME: IM\_05\_4 (4GB\_4\_4GB)

COMMENT: INT MTL

ASSEMBLY: UL U419

DESCRIPTION: TYPICAL 3-5/8" INTERIOR WALL  
3-HR RATED

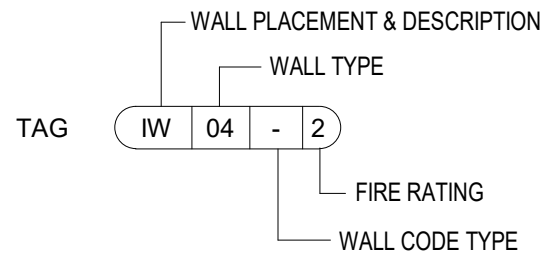

NAME: IW\_04\_2 (2GB\_6\_2GB)

COMMENT: INT WD

ASSEMBLY: UL U301

DESCRIPTION: TYPICAL 2x6 INTERIOR WALL  
2-HR RATED

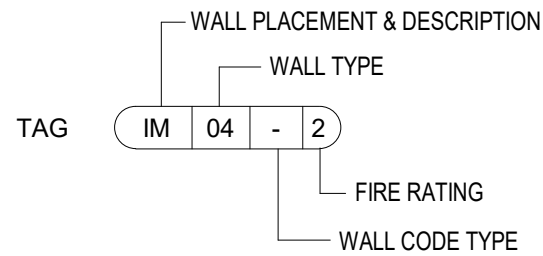

NAME: IM\_04\_2 (2GB\_6\_2GB)

COMMENT: INT MTL

ASSEMBLY: B2010

DESCRIPTION: TYPICAL 6" INTERIOR WALL  
2-HR RATED

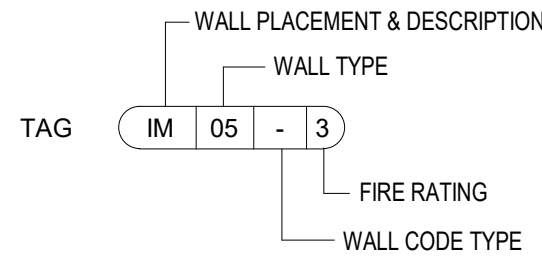

NAME: IM\_05\_3 (3GB\_6\_3GB)

COMMENT: INT MTL

ASSEMBLY: B2010

DESCRIPTION: TYPICAL 6" INTERIOR WALL  
3-HR RATED

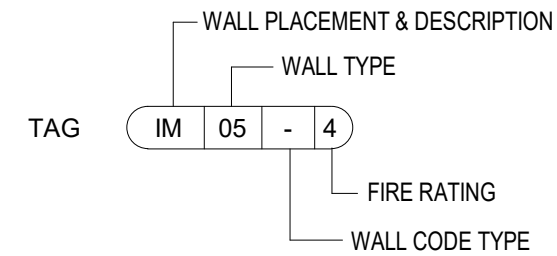

NAME: IM\_05\_4 (4GB\_6\_4GB)

COMMENT: INT MTL

ASSEMBLY: UL U419

DESCRIPTION: TYPICAL 6" INTERIOR WALL  
3-HR RATED

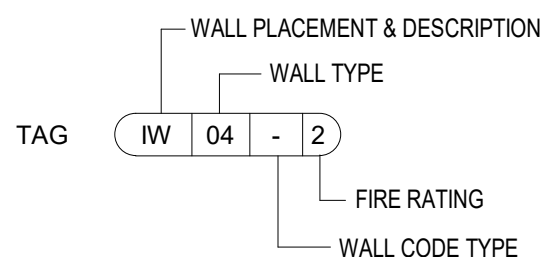

NAME: IW\_04\_2 (2GB\_8\_2GB)

COMMENT: INT WD

ASSEMBLY: UL U301

DESCRIPTION: TYPICAL 2x8 INTERIOR WALL  
2-HR RATED

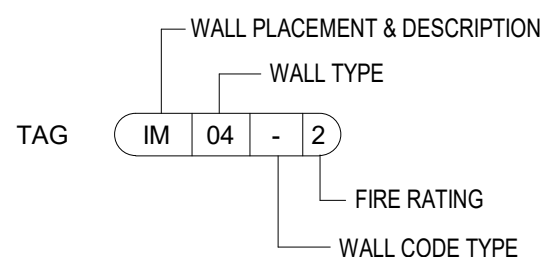

NAME: IM\_04\_2 (2GB\_8\_2GB)

COMMENT: INT MTL

ASSEMBLY: B2010

DESCRIPTION: TYPICAL 8" INTERIOR WALL  
2-HR RATED

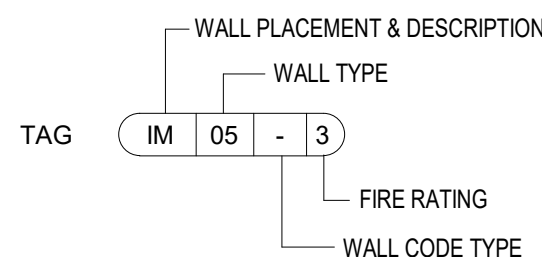

NAME: IM\_05\_3 (3GB\_8\_3GB)

COMMENT: INT MTL

ASSEMBLY: B2010

DESCRIPTION: TYPICAL 8" INTERIOR WALL  
3-HR RATED

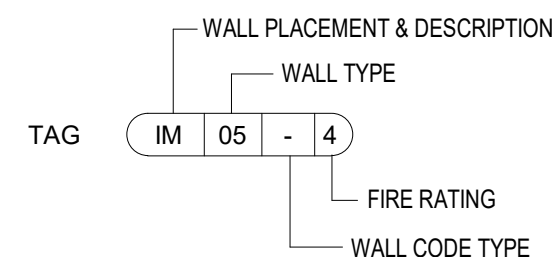

NAME: IM\_05\_4 (4GB\_8\_4GB)

COMMENT: INT MTL

ASSEMBLY: UL U419

DESCRIPTION: TYPICAL 8" INTERIOR WALL  
3-HR RATED



**ORB ASSEMBLIES**

**INTERIOR WALLS**

**07-IW/IM-04/05**

DATE:  
03/01/23

J:\Andres\_Fernandez\Revise\_to\_HIVE\Wall\_Assemblies\ORB\_Assemblies\_Split\_Walls\_2023.rvt 5/3/2023 3:05:32 PM

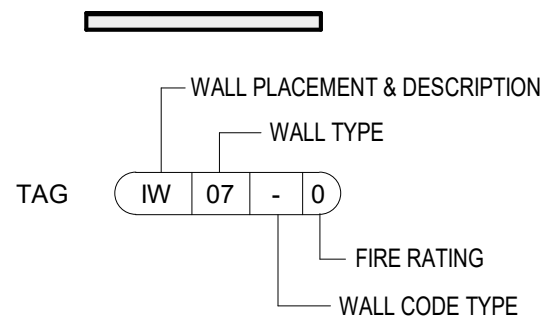

NAME: IW\_07\_0 (1GB\_4\_NA)  
 COMMENT: INT WD  
 ASSEMBLY: N/A  
 DESCRIPTION: TYPICAL 2x4 INTERIOR WALL  
 NO-GYP INSIDE NON-RATED

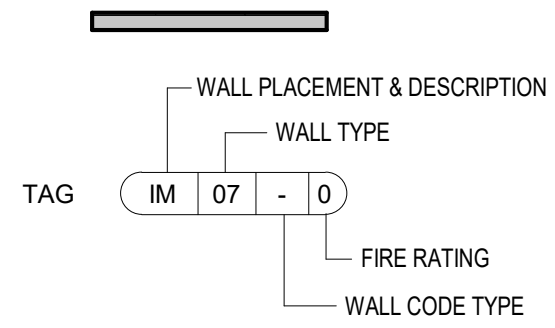

NAME: IM\_07\_0 (1GB\_4\_NA)  
 COMMENT: INT MTL  
 ASSEMBLY: IBC 803.15.2 (2018)  
 DESCRIPTION: TYPICAL 3-5/8" INTERIOR WALL  
 NO-GYP INSIDE NON-RATED

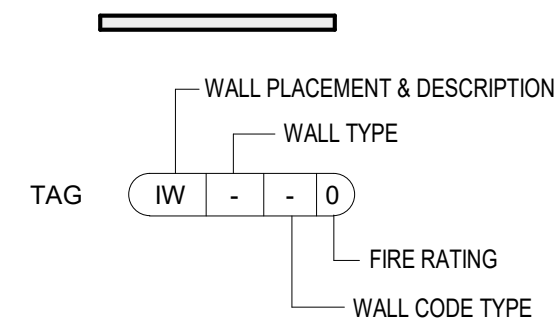

NAME: IW\_08\_0 (NA\_4\_NA)  
 COMMENT: INT WD  
 ASSEMBLY: N/A  
 DESCRIPTION: 2x4 STUD ONLY WALL  
 NON-RATED MODELING WALL

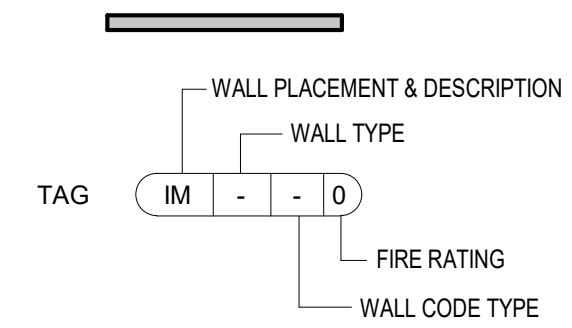

NAME: IM\_08\_0 (NA\_4\_NA)  
 COMMENT: INT MTL  
 ASSEMBLY: N/A  
 DESCRIPTION: 3-5/8" STUD ONLY WALL  
 NON-RATED MODELING WALL



**ORB ASSEMBLIES**  
**INTERIOR WALLS**

**07-IW/IM-07/08**

DATE:  
 03/01/23

U:\Andres\_Fernandez\Revise to HIVE\Wall Assemblies\ORB Assemblies\_Split\_Walls\_2023.rvt 5/3/2023 3:05:33 PM

WALL PLACEMENT & DESCRIPTION

WALL TYPE

TAG: FR 01 - 0

FIRE RATING

WALL CODE TYPE

NAME: FRW\_01\_0 (1GB\_4\_NA)  
 COMMENT: FURROUT WD  
 ASSEMBLY: N/A  
 DESCRIPTION: FURROUT 2x4 FRAMING WITH 1-GYP NON-RATED

WALL PLACEMENT & DESCRIPTION

WALL TYPE

TAG: FR 02 - 0

FIRE RATING

WALL CODE TYPE

NAME: FRW\_02\_0 (2GB\_4\_NA)  
 COMMENT: FURROUT WD  
 ASSEMBLY: N/A  
 DESCRIPTION: FURROUT 2x4 FRAMING WITH 2-GYP NON-RATED

WALL PLACEMENT & DESCRIPTION

WALL TYPE

TAG: FR 01 - 0

FIRE RATING

WALL CODE TYPE

NAME: FRM\_01\_0 (1GB\_4\_NA)  
 COMMENT: FURROUT MTL  
 ASSEMBLY: N/A  
 DESCRIPTION: FURROUT 3-5/8" FRAMING WITH 1-GYP NON-RATED

WALL PLACEMENT & DESCRIPTION

WALL TYPE

TAG: FR 04 - 0

FIRE RATING

WALL CODE TYPE

NAME: FRM\_04\_0 (2GB\_4\_FLAT\_NA)  
 COMMENT: FURROUT MTL  
 ASSEMBLY: N/A  
 DESCRIPTION: FURROUT 1-3/8" FRAMING WITH 2-GYP NON-RATED

WALL PLACEMENT & DESCRIPTION

WALL TYPE

TAG: FR 03 - 0

FIRE RATING

WALL CODE TYPE

NAME: FRW\_03\_0 (1GB\_4 Flat\_NA)  
 COMMENT: FURROUT WD  
 ASSEMBLY: N/A  
 DESCRIPTION: FURROUT 2x FLAT FRAMING WITH 1-GYP NON-RATED AT CMU/CONCRETE WALLS

WALL PLACEMENT & DESCRIPTION

WALL TYPE

TAG: FR 04 - 0

FIRE RATING

WALL CODE TYPE

NAME: FRW\_04\_0 (2GB\_4 Flat\_NA)  
 COMMENT: FURROUT WD  
 ASSEMBLY: N/A  
 DESCRIPTION: FURROUT 2x FLAT FRAMING WITH 2-GYP & SHEAR TO MATCH CORRIDOR NON-RATED

WALL PLACEMENT & DESCRIPTION

WALL TYPE

TAG: FR 02 - 0

FIRE RATING

WALL CODE TYPE

NAME: FRM\_02\_0 (2GB\_4\_NA)  
 COMMENT: FURROUT MTL  
 ASSEMBLY: N/A  
 DESCRIPTION: FURROUT 3-5/8" FRAMING WITH 2-GYP NON-RATED

WALL PLACEMENT & DESCRIPTION

WALL TYPE

TAG: FM 03 - 0

FIRE RATING

WALL CODE TYPE

NAME: FRM\_03\_0 (1GB\_4 FLAT\_NA)  
 COMMENT: FURROUT MTL  
 ASSEMBLY: N/A  
 DESCRIPTION: FURROUT 1-3/8" FRAMING WITH 1-GYP NON-RATED

WALL PLACEMENT & DESCRIPTION

WALL TYPE

TAG: FR 06 - 0

FIRE RATING

WALL CODE TYPE

NAME: FRM\_06\_0 (2GB\_RC\_NA)  
 COMMENT: FURROUT MTL  
 ASSEMBLY: N/A  
 DESCRIPTION: FURROUT 1/2" RC-CHANNELS FRAMING WITH 2-GYP NON-RATED

WALL PLACEMENT & DESCRIPTION

WALL TYPE

TAG: FR 05 - 0

FIRE RATING

WALL CODE TYPE

NAME: FRM\_05\_0 (1GB\_RC\_NA)  
 COMMENT: FURROUT MTL  
 ASSEMBLY: N/A  
 DESCRIPTION: FURROUT 1/2" RC-CHANNELS FRAMING WITH 1-GYP NON-RATED



**ORB ASSEMBLIES**  
FURRING WALLS

**08-FURR**

DATE:  
03/01/23



U:\Andres\_Fernandez\Revise to HIVE\Wall Assemblies\ORB Assemblies\_Split\_Walls\_2023.rvt 5/3/2023 3:05:33 PM



WALL PLACEMENT & DESCRIPTION  
WALL TYPE  
TAG **FL 11 2**  
FIRE RATING

NAME: FL\_11\_2\_GARAGE CONCRETE TOPPING SLAB  
COMMENT: CONCRETE GARAGE SLAB  
ASSEMBLY: UL J704  
DESCRIPTION: TYP. GARAGE 2-HR POST-TENSION CONCRETE SLAB



WALL PLACEMENT & DESCRIPTION  
WALL TYPE  
TAG **FL 07 2**  
FIRE RATING

NAME: FL\_07\_2\_GARAGE CONCRETE SLAB - 8"  
COMMENT: CONCRETE GARAGE SLAB  
ASSEMBLY: IBC 2018 TABLE 721.1 (2)  
DESCRIPTION: TYP. GARAGE 2-HR POST-TENSION CONCRETE SLAB



WALL PLACEMENT & DESCRIPTION  
WALL TYPE  
TAG **FL 04 1**  
FIRE RATING

NAME: FL\_04\_1\_CORRIDOR FLOOR 2x10  
COMMENT: BUILDING CORRIDOR FLOOR  
ASSEMBLY: L512  
DESCRIPTION: TYPICAL 1-HR CORRIDOR FLOOR



WALL PLACEMENT & DESCRIPTION  
WALL TYPE  
TAG **FL 01 3**  
FIRE RATING

NAME: FL\_01\_3\_Podium Concrete Slab- 14"  
COMMENT: CONCRETE PODIUM SLAB  
ASSEMBLY: IBC 2018 TABLE 721.1 (3) ITEM NO 1-1.1  
DESCRIPTION: 3-HR RATED\_SILICEOUS AGGREGATE CONCRETE TYPICAL PODIUM SLAB

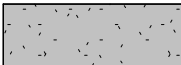

WALL PLACEMENT & DESCRIPTION  
WALL TYPE  
TAG **FL 12 1**  
FIRE RATING

NAME: FL\_12\_1\_OPEN WEB TRUSS @ BALCONIES  
COMMENT: BALCONY FLOOR  
ASSEMBLY: UL L546  
DESCRIPTION: 1 HR FLOOR/CEILING OPEN WEB TRUSS AT BALCONIES WITH RESILIENT CLIP

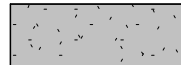

WALL PLACEMENT & DESCRIPTION  
WALL TYPE  
TAG **FL 08 0**  
FIRE RATING

NAME: FL\_08\_0\_SLAB ON GRADE 8"  
COMMENT: CONCRETE SLAB ON GRADE  
ASSEMBLY:  
DESCRIPTION: TYP. NON RATED SLAB ON GRADE



WALL PLACEMENT & DESCRIPTION  
WALL TYPE  
TAG **FL 05 1**  
FIRE RATING

NAME: FL\_05\_1\_Balcony Floor 2x10  
COMMENT: UNIT BALCONY FLOOR  
ASSEMBLY: L512  
DESCRIPTION: TYP. 1-HR RATED BALCONY FLOOR



WALL PLACEMENT & DESCRIPTION  
WALL TYPE  
TAG **FL 02 1**  
FIRE RATING

NAME: FL\_02\_1\_UNIT FLOOR TO CEILING  
COMMENT: UNIT FLOOR  
ASSEMBLY: UL L550  
DESCRIPTION: TYP. 1-HR RATED UNIT FLOOR



WALL PLACEMENT & DESCRIPTION  
WALL TYPE  
TAG **FL 09 1**  
FIRE RATING

NAME: FL\_09\_1\_LW CONCRETE ON METAL DECK  
COMMENT: LIGHT WEIGHT CONCRETE ON 3 1/2" METAL DECK  
ASSEMBLY: D902  
DESCRIPTION: 1 HR UNPROTECTED DECK



WALL PLACEMENT & DESCRIPTION  
WALL TYPE  
TAG **FL 06 1**  
FIRE RATING

NAME: FL\_06\_1\_EXTERIOR CORRIDOR FLOOR 2x10  
COMMENT: BUILDING CORRIDOR FLOOR  
ASSEMBLY: 2012 IBC TABLE 721.1 (3). ITEM 13-1.2  
DESCRIPTION: 1-HR CORRIDOR FLOOR AT EXTERIOR SOFFIT CONDITION



WALL PLACEMENT & DESCRIPTION  
WALL TYPE  
TAG **FL 03 1**  
FIRE RATING

NAME: FL\_03\_1\_UNIT FLOOR TO CEILING ( TO OTHER USES)  
COMMENT: UNIT FLOOR  
ASSEMBLY: UL L574  
DESCRIPTION: 1-HR RATED UNIT FLOOR WITH ENHANCED STC RATING



**ORB ASSEMBLIES**  
FLOORS AND CONCRETE SLABS

**13-FL-1**  
DATE:  
07/21/21

U:\Andres\_Fernandez\Revise to\_HIVE\Wall\_Assemblies\ORB\_Assemblies\_Split\_Walls\_2023.rvt 5/3/2023 3:05:34 PM

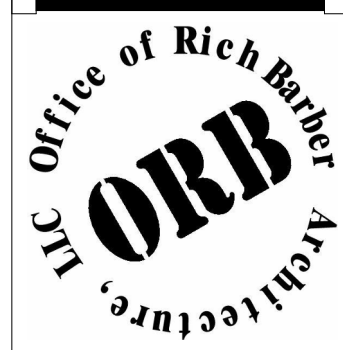

**ORB ASSEMBLIES**  
**ROOFS**

Diagram showing a rectangular wall placement with a tag **RF 05 2**. The tag is divided into three sections: 'RF', '05', and '2'. Lines connect the tag to labels: 'WALL PLACEMENT & DESCRIPTION' (top), 'WALL TYPE' (middle), and 'FIRE RATING' (bottom).

**NAME:** RF\_05\_2 CONCRETE OVER METAL DECK  
**COMMENT:** NON-RATED ROOF  
**ASSEMBLY:** UL S721  
**DESCRIPTION:** ROOF COVERING OVER METAL DECK

Diagram showing a rectangular wall placement with a tag **RF 03 1**. The tag is divided into three sections: 'RF', '03', and '1'. Lines connect the tag to labels: 'WALL PLACEMENT & DESCRIPTION' (top), 'WALL TYPE' (middle), and 'FIRE RATING' (bottom).

**NAME:** RF\_03\_1 SOFFITS  
**COMMENT:** SMALL PROJECTIONS SOFFIT  
**ASSEMBLY:** 2018 IBC TABLE 721.1(3), ITEM 13-1.2  
**DESCRIPTION:** 1-HR WOOD SOFFIT TPO FINISH

Diagram showing a rectangular wall placement with a tag **RF 01 1**. The tag is divided into three sections: 'RF', '01', and '1'. Lines connect the tag to labels: 'WALL PLACEMENT & DESCRIPTION' (top), 'WALL TYPE' (middle), and 'FIRE RATING' (bottom).

**NAME:** RF\_01\_1 TOP CHORD  
**COMMENT:** BUILDING ROOF TOP CORD OVERLAY TO 2'-0" MIN WIDTH  
**ASSEMBLY:** P531  
**DESCRIPTION:** TYP. 1-HR WOOD TRUSS ROOF

Diagram showing a rectangular wall placement with a tag **RF 05 3**. The tag is divided into three sections: 'RF', '05', and '3'. Lines connect the tag to labels: 'WALL PLACEMENT & DESCRIPTION' (top), 'WALL TYPE' (middle), and 'FIRE RATING' (bottom).

**NAME:** RF\_05\_3 CONCRETE OVER METAL DECK  
**COMMENT:** NON-RATED ROOF  
**ASSEMBLY:** UL S721  
**DESCRIPTION:** ROOF COVERING OVER METAL DECK

Diagram showing a rectangular wall placement with a tag **RF 04 0**. The tag is divided into three sections: 'RF', '04', and '0'. Lines connect the tag to labels: 'WALL PLACEMENT & DESCRIPTION' (top), 'WALL TYPE' (middle), and 'FIRE RATING' (bottom).

**NAME:** RF\_04\_0 NON-RATED  
**COMMENT:** NON-RATED ROOF  
**ASSEMBLY:** N/A  
**DESCRIPTION:** WOOD ROOF

Diagram showing a rectangular wall placement with a tag **RF 01 1**. The tag is divided into three sections: 'RF', '01', and '1'. Lines connect the tag to labels: 'WALL PLACEMENT & DESCRIPTION' (top), 'WALL TYPE' (middle), and 'FIRE RATING' (bottom).

**NAME:** RF\_01\_1 BOTTOM CHORD  
**COMMENT:** BUILDING ROOF TOP CORD UNDERLAY TO 2'-0" MIN WIDTH  
**ASSEMBLY:** P531  
**DESCRIPTION:** TYP. 1-HR WOOD TRUSS ROOF

Diagram showing a rectangular wall placement with a tag **RF 05 1**. The tag is divided into three sections: 'RF', '05', and '1'. Lines connect the tag to labels: 'WALL PLACEMENT & DESCRIPTION' (top), 'WALL TYPE' (middle), and 'FIRE RATING' (bottom).

**NAME:** RF\_05\_1 CONCRETE OVER METAL DECK  
**COMMENT:** CONCRETE OVER METAL DECK ROOF  
**ASSEMBLY:** UL S721  
**DESCRIPTION:** ROOF COVERING OVER METAL DECK

Diagram showing a rectangular wall placement with a tag **RF 02 1**. The tag is divided into three sections: 'RF', '02', and '1'. Lines connect the tag to labels: 'WALL PLACEMENT & DESCRIPTION' (top), 'WALL TYPE' (middle), and 'FIRE RATING' (bottom).

**NAME:** RF\_02\_1 BALCONY/STAIR/ELEVATOR ROOF  
**COMMENT:** ROOF OVER BALCONY/STAIRS/ELEVATORS  
**ASSEMBLY:** RC 2601 GA-600-2018  
**DESCRIPTION:** TYP. 1-HR BALCONY ROOF GYP. FINISH

**14-RF-1**  
DATE: 08/10/21

J:\Andres\_Fernandez\Revise\_to\_HIVE\Wall\_Assemblies\ORB\_Assemblies\_Split\_Walls\_2023.rvt 5/3/2023 3:05:34 PM



**ORB ASSEMBLIES**  
**CEILINGS - NON RATED**

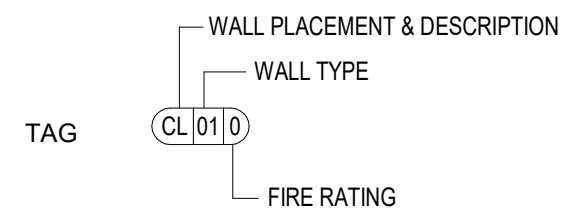
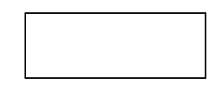

NAME: CL\_01\_0 SUSPENDED CEILING  
COMMENT: FURR DOWN CEILING, NOT PART OF ASSEMBLY  
ASSEMBLY: C3030220  
DESCRIPTION: GYPSUM WALL BOARD OVER 3 5/8" METAL STUDS

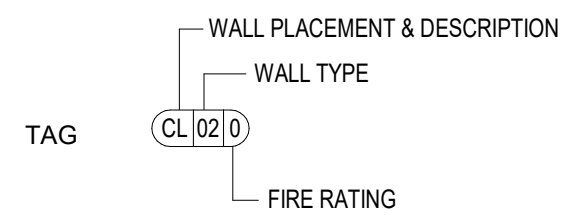
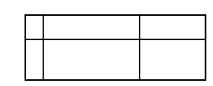

NAME: CL\_02\_0 2'x2' SUSPENDED TILE CEILING  
COMMENT: SUSPENDED ACOUSTICAL CEILING TILES  
ASSEMBLY: C3030210  
DESCRIPTION: 24"x24" 3/4" CEILING TILES IN 15/16" CEILING GRID

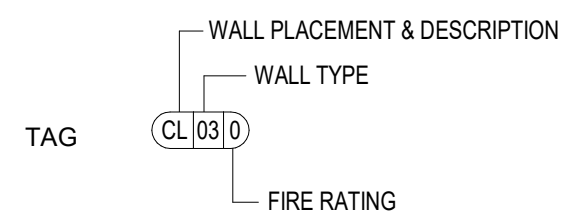
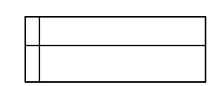

NAME: CL\_03\_0 2'x4' SUSPENDED TILE CEILING  
COMMENT: SUSPENDED ACOUSTICAL CEILING TILES  
ASSEMBLY: C3030210  
DESCRIPTION: 24"x24" 3/4" CEILING TILES IN 15/16" CEILING GRID

**15-CLG**  
DATE: 03/01/23